

# FUJIFILM

DIGITAL CAMERA

# FINEPIX S8100fd

## OWNER'S MANUAL

This manual will show you how to use your FUJIFILM DIGITAL CAMERA FinePix S8100fd correctly. Please follow the instructions carefully.

**digital**  
tools for the imagination.

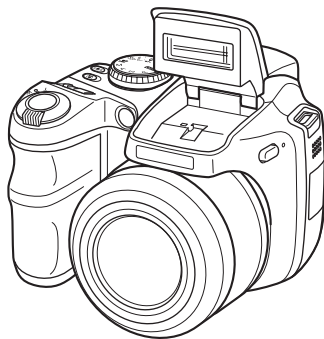

**xD**  
xD-Picture Card™



**Exif Print**



Getting Ready

Using the Camera

Advanced Features • Photography

• Playback

• Movie

Settings

Camera Connection

Software  
Installation

Appendices

Troubleshooting

BL00730-200(1) 

# Warning

To prevent fire or shock hazard, do not expose the unit to rain or moisture.

## For customers in the U.S.A.

*Tested To Comply  
With FCC Standards  
FOR HOME OR OFFICE USE*

### FCC Statement

This device complies with Part 15 of the FCC Rules. Operation is subject to the following two conditions: (1) This device may not cause harmful interference, and (2) this device must accept any interference received, including interference that may cause undesired operation.

### CAUTION

This equipment has been tested and found to comply with the limits for a Class B digital device, pursuant to Part 15 of the FCC Rules. These limits are designed to provide reasonable protection against harmful interference in a residential installation. This equipment generates, uses, and can radiate radio frequency energy and, if not installed and used in accordance with the instructions, may cause harmful interference to radio communications. However, there is no guarantee that interference will not occur in a particular installation. If this equipment does cause harmful interference to radio or television reception, which can be determined by turning the equipment off and on, the user is encouraged to try to correct the interference by one or more of the following measures:

- Reorient or relocate the receiving antenna.
- Increase the separation between the equipment and receiver.
- Connect the equipment into an outlet on a circuit different from that to which the receiver is connected.
- Consult the dealer or an experienced radio/TV technician for help.

You are cautioned that any changes or modifications not expressly approved in this manual could void the user's authority to operate the equipment.

### Notes on the Grant:

To comply with Part 15 of the FCC Rules, this product must be used with a Fujifilm-specified ferrite-core A/V cable, USB cable, and DC supply cord.

## For customers in Canada

### CAUTION

This Class B digital apparatus complies with Canadian ICES-003.

**Please read the Safety Notes (separate note "Notes and Cautions") and make sure you understand them before using the camera.**

## NOTICE

**BEFORE OPENING THE CD-ROM PROVIDED BY FUJIFILM CORPORATION, PLEASE READ THIS END USER LICENSE AGREEMENT CAREFULLY. ONLY IF YOU AGREE WITH THIS AGREEMENT, SHOULD YOU USE THE SOFTWARE RECORDED ON THE CD-ROM. BY OPENING THE PACKAGE, YOU ACCEPT AND AGREE TO BE BOUND BY THIS AGREEMENT.**

## End User License Agreement

This End User License Agreement ("Agreement") is an agreement between FUJIFILM Corporation ("FUJIFILM") and you, which sets forth the terms and conditions of the license granted for you to use the software provided by FUJIFILM.

The CD-ROM contains third party software. In case a separate agreement is provided by a third party supplier for its software, the provisions of such separate agreement shall apply to the use of such third party software, prevailing over those of this Agreement.

### 1. Definitions.

- (a) "Media" means the CD-ROM titled "Software for FinePix" which is provided to you together with this Agreement.
- (b) "Software" means the software which is recorded on Media.
- (c) "Documentation" means the operation manuals of Software and other related written materials which are provided to you together with Media.
- (d) "Product" means Media (including Software) and Documentation collectively.

### 2. Use of Software.

FUJIFILM grants to you a nontransferable, nonexclusive license:

- (a) to install one copy of Software onto one computer in binary machine executable form;
- (b) to use Software on the computer onto which Software is installed; and
- (c) to make one backup copy of Software.

### 3. Restrictions.

- 3.1 You shall not distribute, rent, lease or otherwise transfer all or any part of Software, Media or Documentation to any third party without FUJIFILM's prior written consent. You also shall not sublicense, assign or otherwise transfer all or any part of the rights granted to you by FUJIFILM under this Agreement without FUJIFILM's prior written consent.
- 3.2 Except as expressly granted by FUJIFILM hereunder, you shall not copy or reproduce all or any part of Software or Documentation.
- 3.3 You shall not modify, adapt or translate Software or Documentation. You also shall not alter or remove copyright and other proprietary notices that appear on or in Software or Documentation.
- 3.4 You shall not, or shall not have any third party, reverse-engineer, decompile, or disassemble Software.

### 4. Ownership.

All copyrights and other proprietary rights to Software and Documentation are owned and retained by FUJIFILM or the third party suppliers as indicated on or in Software or Documentation. Nothing contained herein shall be construed, expressly or implicitly, as transferring or granting any right, license, or title to you other than those explicitly granted under this Agreement.

### 5. Limited Warranty.

FUJIFILM warrants to you that Media is free from any defect in material and workmanship under normal use for ninety (90) days from the date of your receipt of Media. Should Media not meet the foregoing warranty, FUJIFILM shall replace such defective Media with other Media bearing no defect. FUJIFILM's entire liability and your sole and exclusive remedy with regard to any defect in Media shall be expressly limited to such FUJIFILM's replacement of Media as provided herein.

### 6. DISCLAIMER OF WARRANTY.

EXCEPT AS PROVIDED IN SECTION 5 HEREIN, FUJIFILM PROVIDES PRODUCT "AS IS" AND WITHOUT WARRANTIES OF ANY KIND, EXPRESS OR IMPLIED, FUJIFILM SHALL MAKE NO WARRANTY, EXPRESS, IMPLIED OR STATUTORY, AS TO ANY OTHER MATTERS, INCLUDING, BUT NOT LIMITED TO NON-INFRINGEMENT OF ANY COPYRIGHT, PATENT, TRADE SECRET, OR ANY OTHER PROPRIETARY RIGHTS OF ANY THIRD PARTY, MERCHANTABILITY, OR FITNESS FOR ANY PARTICULAR PURPOSE.

### 7. LIMITATION OF LIABILITY.

IN NO EVENT SHALL FUJIFILM HAVE ANY LIABILITY FOR ANY GENERAL, SPECIAL, DIRECT, INDIRECT, CONSEQUENTIAL, INCIDENTAL, OR OTHER DAMAGES (INCLUDING DAMAGES FOR LOSS OF PROFITS OR LOST SAVINGS) INCURRED FROM THE USE OF OR INABILITY TO USE PRODUCT EVEN IF FUJIFILM HAS BEEN ADVISED OF THE POSSIBILITY OF SUCH DAMAGES.

### 8. No export.

You acknowledge that neither Software nor any part thereof, will be transferred, or exported to any country or used in any manner in violation of any export control laws and regulations to which Software is subject.

### 9. Termination.

In case you breach any of the terms and conditions hereof, FUJIFILM may immediately terminate this Agreement without any notice.

### 10. Term.

This Agreement is effective until the date when you cease to use Software, unless earlier terminated in accordance with Section 9 hereof.

### 11. Obligation upon termination.

Upon termination or expiration of this Agreement, you shall, at your own responsibility and expense, delete or destroy immediately all Software (including its copies), Media and Documentation.

### 12. Governing Law.

This Agreement shall be governed by and construed in accordance with laws of Japan.

# EC Declaration of Conformity

We

Name: FUJIFILM Electronic Imaging Europe GmbH  
Address: Benzstrasse 2  
47533 Kleve, Germany

declare that the product

Product Name: FUJIFILM DIGITAL CAMERA FinePix S8100fd  
Manufacturer's Name: FUJIFILM Corporation  
Manufacturer's Address: 7-3, AKASAKA 9-CHOME, MINATO-KU,  
TOKYO 107-0052, JAPAN

conforms to the following Standards:

Safety: EN60065: 2002 + A1  
EMC: EN55022: 1998 + A1: 2000 + A2: 2003 Class B  
EN55024: 1998 + A1: 2001 + A2: 2003  
EN61000-3-2: 2000 + A2: 2005  
EN61000-3-3: 1995 + A1: 2001 + A2: 2003

following the provision of the EMC Directive (2004/108/EC) and Low Voltage Directive (2006/95/EC).



Kleve, Germany

February 1, 2008

Place

Date

Signature/Managing Director



This product comes with batteries. When these are empty, you shouldn't throw them away but deliver them as domestic chemical refuse.

# Disposal of Electric and Electronic Equipment in Private Households

---

## Disposal of used Electrical & Electronic Equipment (Applicable in the European Union and other European countries with separate collection systems)



This symbol on the product, or in the manual and in the warranty, and/or on its packaging indicates that this product shall not be treated as household waste.

Instead it should be taken to an applicable collection point for the recycling of electrical and electronic equipment.

By ensuring this product is disposed of correctly, you will help prevent potential negative consequences to the environment and human health, which could otherwise be caused by inappropriate waste handling of this product.

If your equipment contains easy removable batteries or accumulators please dispose these separately according to your local requirements.

The recycling of materials will help to conserve natural resources. For more detailed information about recycling of this product, please contact your local city office, your household waste disposal service or the shop where you have purchased the product.

### **In Countries outside the EU:**

If you wish to discard this product, please contact your local authorities and ask for the correct way of disposal.

# Contents



Warning.....	2
IMPORTANT .....	3
EC Declaration of Conformity.....	4
Disposal of Electric and Electronic Equipment in Private Households .....	5
Contents.....	6
About this Manual .....	9
Accessories Included .....	10
Camera Parts and Features.....	11
Example of screen Text Display.....	13

## Getting Ready













Attaching the Strap and Lens Cap .....	14
Loading the Batteries .....	15
Checking the battery charge .....	16
Loading the Memory Card.....	18
Turning On and Off .....	21
Setting the language, date, and time .....	22
Correcting the Date and Time.....	24
Selecting the Language .....	25

## Using the Camera

Taking Pictures (  AUTO Mode).....	26
Using Intelligent Face Detection when taking pictures.....	29
Using the Dual Image Stabilizer function when taking pictures .....	31
Taking pictures with the focus and exposure locked .....	32
AF-assist illuminator.....	34
Using zoom function .....	35

Adjusting the shot composition .....	35
Viewing the Images .....	37
 Erasing the Images/Movies .....	42
Using the erase button (  /  ).....	42
Erasing the images using [PLAYBACK MENU].....	42

## Advanced Features — Photography



Using the Shooting Functions —	
Procedure of Setting .....	45
Setting the Shooting Mode .....	49
 <b>AUTO</b> AUTO] .....	49
[  PICTURE STABILIZATION] .....	49
[  NATURAL LIGHT] .....	50
[  NATURAL &  ].....	50
[  ZOOM BRACKETING] .....	51
[SP SCENE POSITION].....	52
[P PROGRAM AE].....	56
[S SHUTTER PRIORITY AE] .....	57
[A APERTURE PRIORITY AE] .....	59
[M MANUAL].....	61
Adjusting the Image Brightness	
(  Exposure Compensation) .....	63
 Macro/  Super Macro (Close-up) .....	65
 Setting the Flash (Intelligent Flash) .....	66
 Taking pictures continuously.....	68
 Instant Zoom.....	71

Using [ <b>F</b> -MODE MENU] (Photography)/ [SHOOTING MENU] .....	73
Setting the [ <b>F</b> -MODE MENU] (Portography) .....	73
Setting the [SHOOTING MENU] .....	73
[ <b>F</b> -MODE MENU] (Photography) .....	76
Changing the sensitivity setting (( <b>ISO</b> ISO)) .....	76
Changing the quality setting (( <b>QUALITY</b> )) .....	77
Changing the FinePix COLOR setting (( <b>FinePix COLOR</b> )) .....	78
[SHOOTING MENU] .....	79
Setting self-timer (( <b>SELF-TIMER</b> )) .....	79
Selecting light metering method (( <b>PHOTOMETRY</b> )) .....	80
Adjusting color balance (( <b>WHITE BALANCE</b> )) .....	81
Focusing the shot quickly (( <b>HIGH-SPEED SHOOTING</b> )) .....	83
Specifying the focusing mode (( <b>FOCUSING</b> )) .....	83
Specifying the focusing area (( <b>AF MODE</b> )) .....	85
Adjust the image outline (hard/soft) (( <b>SHARPNESS</b> )) .....	87
Adjust the amount of light emitted by the flash (( <b>FLASH</b> ] (Brightness Adjustment)) ....	87
Photograph the same image with different exposure (( <b>BRACKETING</b> )) .....	88

## Advanced Features — Playback

Playback Information .....	89
Using [ <b>F</b> -MODE MENU] (Playback)/ [PLAYBACK MENU] .....	90
Setting the [ <b>F</b> -MODE MENU] (Portography) .....	90
Setting the [PLAYBACK MENU] .....	90
[ <b>F</b> -MODE MENU] (Playback) .....	91
Setting automatic playback (( <b>SLIDE SHOW</b> )) .....	91
DPOF set frame (( <b>PRINT ORDER (DPOF)</b> )) .....	91
[PLAYBACK MENU] .....	96
Rotating the images (( <b>IMAGE ROTATE</b> )) .....	96
Protecting the images (( <b>PROTECT</b> )) .....	97
Copying the images (( <b>COPY</b> )) .....	98
Adding voice memos to the images (( <b>VOICE MEMO</b> )) .....	100
Trimming the images (( <b>TRIMMING</b> )) .....	103

## Advanced Features — Movie

 Recording Movies .....	105
Changing movie size .....	107
 Playing Back Movies .....	108

**Continued** ➔

<b>Settings</b>	
Setting Silent Mode .....	110
[ <b>SET</b> ] SET-UP].....	111
Using the [SET-UP] menu.....	111
[SET-UP] menu option .....	112
<b>Camera Connection</b>	
Connecting to a TV .....	120
Using the AC power adapter (sold separately) .....	121
Connecting Camera Directly to Printer — PictBridge Function .....	122
<b>Software Installation</b>	
Installation on a Windows PC .....	126
Installation on a Mac OS X .....	128
Connecting to a PC .....	131
Using FinePixViewer .....	134
<b>Appendices</b>	
System Expansion Option.....	135
Accessories Guide .....	136
Using Your Camera Correctly .....	137
Discharging rechargeable batteries .....	138
Notes on the <b>xD-Picture Card</b> <sup>™</sup> , the SD Memory Card and the Internal Memory .....	139
Warning Displays .....	140
<b>Troubleshooting</b>	
Troubleshooting .....	144

Specifications .....	150
Explanation of Terms .....	156
FUJIFILM Digital Camera Worldwide Network.....	158

**Usable Memory Cards**

You can use the **xD-Picture Card**, the SD Memory Card and the SDHC Memory Card with the FinePix S8100fd. In this Owner's Manual, these cards are expressed as "Memory Card" and "SD Memory Card".



# About this Manual

## ■ About marks

### ! CAUTION

This mark denotes issues that may affect the camera's operation.

### ✓ CHECK

This mark denotes points to notice in the camera's operation.

### 📄 MEMO

This mark denotes additional topics that complement the basic operating procedures.

## ■ Usable Memory Cards

You can use the **xD-Picture Card**, the SD Memory Card and the SDHC Memory Card with the FinePix S8100fd. In this Owner's Manual, these cards are expressed as "Memory Card" and "SD Memory Card".

## ■ 4-direction (▲▼◀▶) button

Up, down, left, and right are indicated by black triangles in the Owner's Manual. Up or down is shown as ▲ or ▼, and left or right is shown as ◀ or ▶.

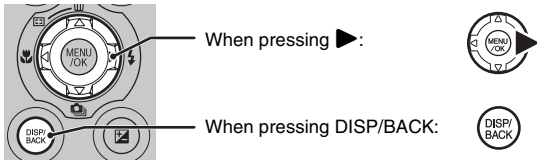

## ■ About the illustration for the screen display

In this Manual, the illustration for the screen display is simplified.

## ■ Note

In this manual, the menu names and messages displayed on the LCD monitor of the camera or PC screen appear in square brackets ([ ]).

# Accessories Included

- AA-size Alkaline Batteries (LR6) (4)



- Shoulder strap (1)

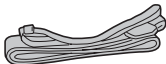

- Lens cap (1 set)



- A/V cable (1)

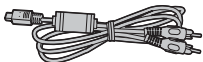

- USB cable (1)

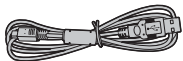

- CD-ROM (1)  
Software for FinePix









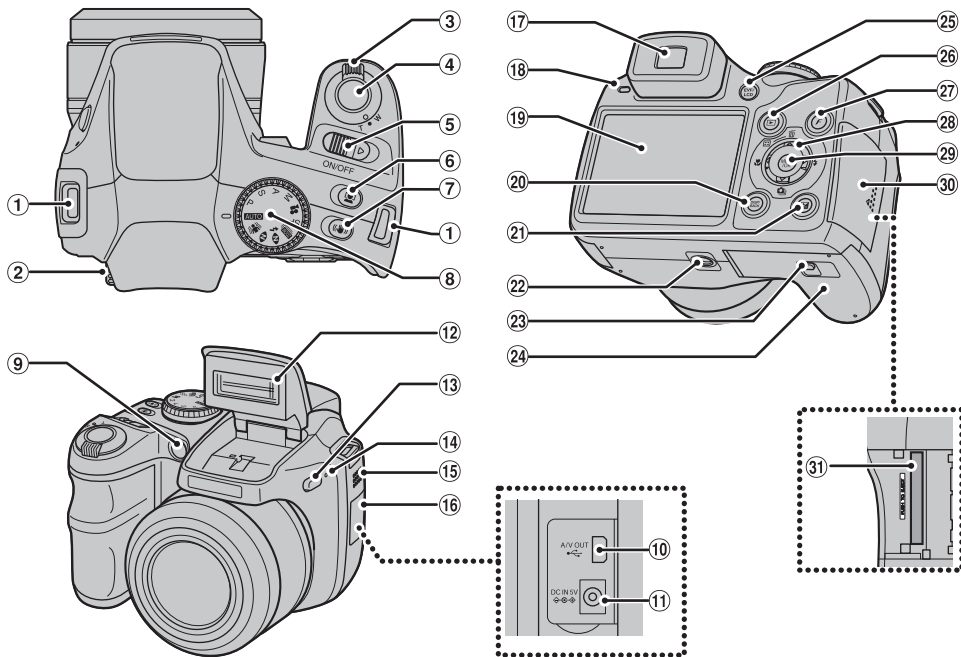

- Owner's Manual (this manual) (1)
- Notes and Cautions (1)

# Camera Parts and Features

- Refer to the pages in parentheses for information on using the camera parts or features.



**Continued** ➔

- ① Strap mount (p.14)
- ② Diopter adjustment dial
- ③ Zoom lever (p.35) (Multi-frame playback (p.40))
- ④ Shutter button
- ⑤ ON/OFF switch (p.21)
- ⑥  Intelligent Face Detection (p.29)/
  - ⑥  Red-eye removal button (p.29)
- ⑦  Dual IS button (p.31)
- ⑧ Mode dial
- ⑨ AF-assist illuminator (p.34)/Self-timer lamp (p.79)
- ⑩  USB socket/A/V OUT (Audio/Visual output) socket (p.120, 122)
- ⑪ DC IN 5V (power input) socket (p.121)
- ⑫ Flash (p.66)
- ⑬  Flash pop-up button (p.66)
- ⑭ Microphone
- ⑮ Speaker
- ⑯ Terminal cover
- ⑰ Viewfinder (EVF)
- ⑱ Indicator lamp (p.29)
- ⑲ LCD monitor
- ⑳ DISP (Display)/BACK button (p.35, 37) (Silent Mode (p.110))
- ㉑  Exposure compensation button (p.63) (Playback Information (p.89))
- ㉒ Tripod mount
- ㉓ Cover lock release catch (p.15)
- ㉔ Battery cover (p.15)
- ㉕ EVF/LCD (monitor selector) button (p.26)
- ㉖  (Playback) button (p.37)
- ㉗  (Photo mode) button (p.73, 90)
- ㉘  (4-direction) button
- ㉙ MENU/OK button
- ㉚ Slot cover (p.18)
- ㉛ Memory Card slot (p.18)

# Example of screen Text Display

## Shooting mode

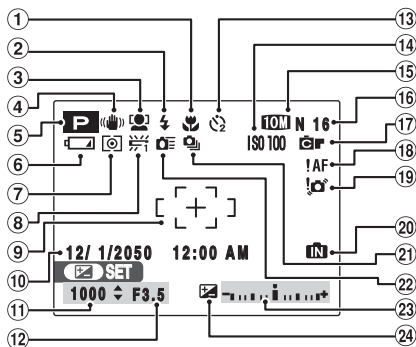

- ① Macro (close-up) (p.65)
- ② Flash (p.66)
- ③ Intelligent Face Detection (p.29)
- ④ Dual IS mode (p.31)
- ⑤ Shooting mode (p.49)
- ⑥ Battery level indicator (p.16)
- ⑦ Photometry (p.80)
- ⑧ White balance (p.81)
- ⑨ AF frame (p.27)
- ⑩ Date/Time (p.22)
- ⑪ Shutter speed (p.57)
- ⑫ Aperture (p.59)
- ⑬ Self-timer (p.79)
- ⑭ Sensitivity (p.76)
- ⑮ 10M N Quality mode (p.77)
- ⑯ Number of available frames (p.154)
- ⑰ FinePix COLOR (p.78)
- ⑱ AFAF warning (p.27)
- ⑲ Camera shake warning (p.140)
- ⑳ Internal memory (p.20)
- ㉑ Continuous shooting (p.68)
- ㉒ High-speed shooting (p.83)
- ㉓ Exposure compensation indicator (p.63)
- ㉔ Exposure compensation (p.63)

## Playback mode

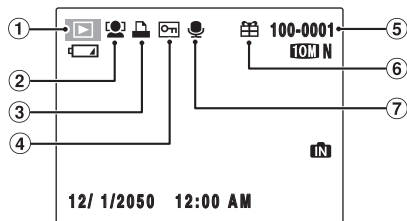

- ① Playback mode (p.37)
- ② Intelligent Face Detection (p.41)
- ③ DPOF (p.91)
- ④ Protection (p.97)
- ⑤ Frame number (p.115)
- ⑥ Present (p.37)
- ⑦ Voice memo (p.100)

FinePix S8100fd has internal memory that can store images without Memory Card.  appears on the screen when the internal memory is active.

# Attaching the Strap and Lens Cap

## Attaching the strap

**1** Attach the strap to the strap mounts on the camera. Once you have attached both ends of the strap, check carefully to make sure that the strap is firmly secured.

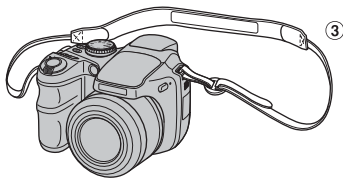
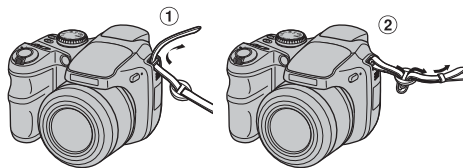

**2** Attach the lens cap cord to the lens cap.

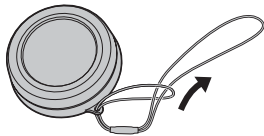

**3** Pull the lens cap cord through the strap.

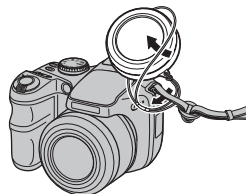

### CAUTION

- Attach the strap correctly to prevent dropping the camera.
- Attach the lens cap cord to prevent losing the lens cap.

## Attaching the lens cap

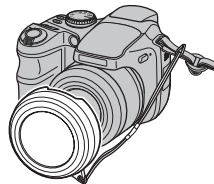

# Loading the Batteries

Batteries are required to operate the digital camera. At first, load the batteries in the camera.

## Compatible batteries

AA-size alkaline batteries (4) or AA-size Ni-MH rechargeable batteries (4) (sold separately)

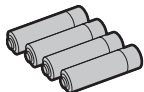

### ! CAUTION

- Never use the following types of batteries, as they could cause serious problems such as battery fluid leakage or overheating:
  1. Batteries with split or peeling outer casings
  2. Combinations of different types of batteries or new and used batteries together
- Do not use manganese, Ni-Cd or lithium batteries.
- Use the same brand and grade AA-size alkaline batteries as those supplied with the camera.

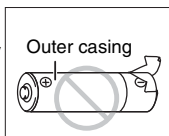

- 1 Slide the lock release catch to open the battery cover.

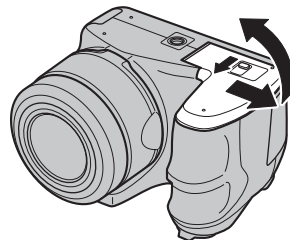

### ! CHECK

Check that the camera is turned off before opening the battery cover.

### ! CAUTION

- Do not open the battery cover while the camera is on. This could damage the Memory Card or ruin the image files on the Memory Card.
- Do not apply force to the battery cover.

**Continued** ➔

## 2 Load the batteries correctly as indicated by the polarity icons.

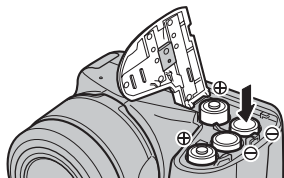

### ! CAUTION

Battery polarity is also indicated on the camera. Match the polarity icons (+ and -) of the batteries to those on the inside of the battery cover.

## 3 Press on the battery cover to push the batteries down. Slide the cover closed.

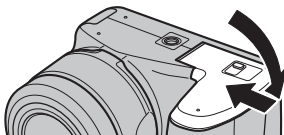

### ✓ CHECK

Make sure to close the battery cover securely until you hear a click.

## Checking the battery charge

Turn the camera on and check the battery charge.

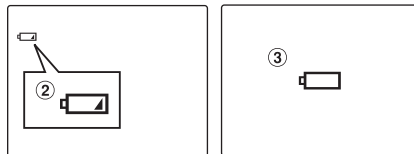

- ① There is ample battery charge. (Not displayed)
- ② There is insufficient charge left in the batteries. The batteries will soon run out. Have a new set of batteries ready. (Lit red)
- ③ The batteries are depleted. The display will shortly go blank and the camera will stop working. Replace or recharge the batteries. (Blinking red)



## ! Notes on batteries

- Soil, such as fingerprints on the poles of the batteries, can shorten time for which the batteries can be used.
- The time for which AA-size alkaline batteries (referred to hereafter simply as alkaline batteries) can be used varies depending on the brand. Some brands of alkaline batteries may stop providing power more quickly than those supplied with the camera. Note also that due to their nature, the time for which alkaline batteries can be used decreases in cold conditions (0°C to +10°C/+32°F to +50°F). For this reason, it is better to use AA-size Ni-MH batteries.
- Due to the nature of the battery, the battery level warning (🔋, 🔋) may appear early when the camera is used in cold locations. Try warming the batteries in your pocket or a similar location before use.
- Depending on the battery type and the level of charge in the batteries, the camera may run out of power without first displaying a battery level warning. This is particularly likely to happen when batteries that have run out of charge once are re-used.
- Depending on the camera mode, the transition from 🔋 to 🔋 may occur more quickly.
- Use Fujifilm Battery charger (sold separately) to charge AA-size Ni-MH batteries.
- When first purchased or if left unused for a long period, the amount of time which AA-size Ni-MH batteries can be used may be short.
- Battery power consumption varies greatly depending on use. When you change to Playback mode from Shooting mode, 🔋 may not occur, however, 🔋 may suddenly blink red and the camera may stop operation.
- See “Notes and Cautions” (included) for more information.

# Loading the Memory Card

Although you can store pictures in the camera's internal memory, you can store many more images on the Memory Card (sold separately). You can use the **xD-Picture Card** and the SD Memory Card with the FinePix S8100fd. In this Owner's Manual, these cards are expressed as "Memory Card".

## SD Memory Cards/SDHC Memory Cards

They are operation-checked at FUJIFILM Corporation.  
Manufacturer: SanDisk

### MEMO

- Compatible models will be updated in our website:  
[http://www.fujifilm.com/products/digital\\_cameras/index.html](http://www.fujifilm.com/products/digital_cameras/index.html)
- Depending on the SD Memory Card, recording of movies may be interrupted.  
Use of above mentioned SD Memory Cards are recommended.
- The camera is not compatible with multimedia cards.

## 1 Open the slot cover.

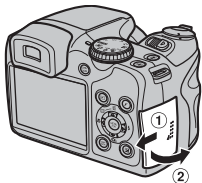

### CAUTION

Do not open the slot cover while the camera is on. This could damage the Memory Card or ruin the image files on the Memory Card.

## 2 Insert a Memory Card.

(xD-Picture Card)

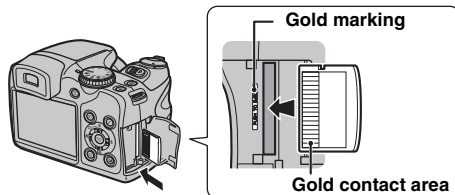

Align the gold marking with the gold contact area, then insert an **xD-Picture Card** completely.

(SD Memory Card)

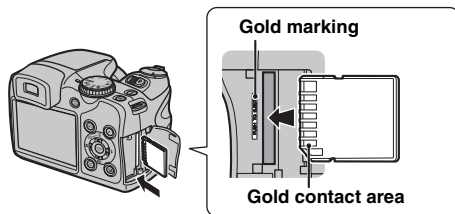

Align the gold marking with the gold contact area, then insert an **SD Memory Card** completely.

**!** CAUTION

Be sure to unlock the protection of the SD Memory Card before inserting it. If it is locked, recording/deleting images, as well as formatting are not available. To unlock the protection, slide the switch back, and the SD Memory Card will work normally.

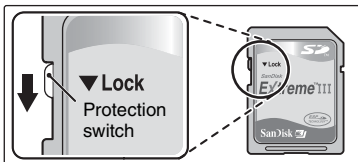
**!** CAUTION

- A new SD Memory Card or a card previously used on a PC or any device other than the camera should be formatted (→p.117) on the camera before use.
- Do not use a miniSD adaptor or a microSD adaptor which have exposed contact areas on the back. Use of these adaptors may cause a malfunction or damage due to the improper contacts.
- A miniSD adaptor or microSD adaptor bigger than SD Memory Card standard size may become stuck. Pulling out forcefully may cause a malfunction. In that case, contact your FUJIFILM dealer.

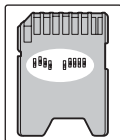
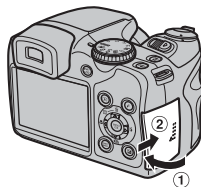
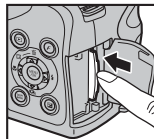
**3** Close the slot cover.**How to replace the Memory Card**

Push the Memory Card into the slot and then slowly remove your finger. The lock is released and the Memory Card is pushed out.

**Continued** ➔

**! CAUTION**

- When storing Memory Cards, make sure that they are kept out of the reach of children. A Memory Card could be swallowed and cause suffocation. If a child swallows a Memory Card, seek medical attention or call emergency number right away.
- If the Memory Cards is oriented incorrectly, it will not go all the way into the slot. Do not apply force when inserting a Memory Card.
- Note that the Memory Cards may spring out if you release your finger quickly from the card immediately after the lock is released.
- Operation of this camera is only guaranteed when it is used with FUJIFILM **xD-Picture Card** and operation-checked SD Memory Card (→p.18).
- See p.139 for information on the **xD-Picture Card**, SD Memory Card and the Internal Memory.

**MEMO**

- The size of an image file varies depending on the subject. For this reason, the number recorded may not represent the actual number of frames.
- See p.154 for information on the standard number of available frames.

**■ About internal memory**

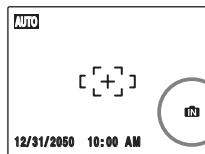

FinePix S8100fd has internal memory that can store images without Memory Card. **iM** appears on the screen when internal memory is active.

**When a Memory Card (sold separately) is inserted**

Record images: Record images to a Memory Card.  
Playback images: Playback images in a Memory Card.

**When a Memory Card (sold separately) is not inserted**

Record images: Record images to internal memory.  
Playback images: Playback images in internal memory.

**■ About images in the internal memory**

Images held in the camera's internal memory may be corrupted or erased due to problems such as camera faults. Save your important data to another media (i.e., DVD-R, CD-R, CD-RW, hard disk, etc.). It is possible to transfer saved images on the internal memory to a Memory Card (→p.98).

# Turning On and Off

## Turning the camera on in Shooting mode

Slide the ON/OFF switch to turn the camera on in Shooting mode. Slide the ON/OFF switch again to turn the camera off.

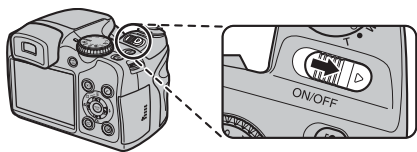



### MEMO Switching between the Shooting and Playback mode

Pressing  when the camera is in Shooting mode switches the camera to the Playback mode. Pressing the shutter button switches the camera to the Shooting mode.

### CAUTION

The ON/OFF switch does not completely disconnect the camera from its power supply.

## Turning the camera on in Playback mode

Press  for about 1 second to turn the camera on in Playback mode. Press  again, or slide the ON/OFF switch to turn the camera off.

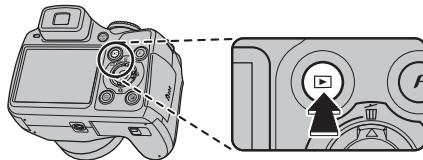

### MEMO

Press the shutter button to switch to the Shooting mode.

## Setting the language, date, and time

When using the camera for the first time after purchasing, the language, date, time, and power management are cleared. Set the language, date, time, and power management.

### MEMO

[START MENU] screen also appears when the batteries have been removed and the camera has been left for a long period. Once the AC power adapter has been connected or the batteries have been installed for 10 hours or more, the camera settings will be retained for roughly 24 hours even if both sources of power are removed.

### 1 [言語/LANG.] screen appears when turning the camera on.



① Press ▲, ▼, ◀, or ▶ to select the language.



② Press MENU/OK to confirm the setting.

### 2 Set the date and time.

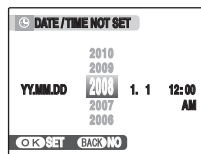

① Press ◀ or ▶ to select Year, Month, Day, Hour, or Minute.



② Press ▲ or ▼ to correct the setting.

### MEMO

- Holding down ▲ or ▼ changes the numbers continuously.
- When the time displayed passes “12”, the AM/PM setting changes.

### 3 Change the date format.



① Press ◀ or ▶ to select the date format.



② Press ▲ or ▼ to set the format.



③ Always press MENU/OK after the settings are completed.

#### Date format

ex. December 1, 2008

[YY.MM.DD]: [2008.12.1]

[MM/DD/YY]: [12/1/2008]

[DD.MM.YY]: [1.12.2008]

### 4 Set the [POWER MANAGEMENT] options.

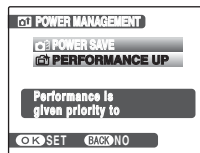

① Select an option from the menu.



② Press MENU/OK to confirm the setting.



#### MEMO

- Settings of [POWER MANAGEMENT]
  - [POWER SAVE]: Intelligent Face detection is set to OFF, and [EVF/LCD MODE] is set to [30fps].
  - [PERFORMANCE UP]: Intelligent Face detection is set to ON, and [EVF/LCD MODE] is set to [60fps].
- To reset, refer to "Using Intelligent Face Detection when taking pictures" (→p.29) and "[SET] SET-UP] menu option" (→p.112).

# Correcting the Date and Time

## 1 Open the [SET-UP] menu.

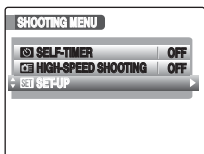

① Press MENU/OK to open the menu.



② Press ▲ or ▼ to select [SET] SET-UP.



③ Press ►.

## 2 Display the [DATE/TIME] screen.

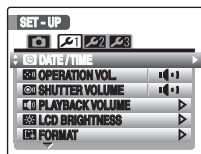

① Press ◀ or ▶ to select .



② Press ▼ to move to menu item.



③ Press ▲ or ▼ to select [DATE/TIME].



④ Press ►.

See "2 Set the date and time." (→p.22).



# Selecting the Language

## 1 Open the [SET-UP] menu.

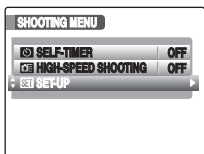

① Press MENU/OK to open the menu.



② Press ▲ or ▼ to select [SET] SET-UP.



③ Press ►.

## 2 Display the [言語/LANG.] screen.

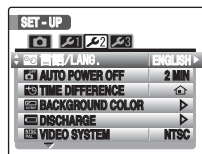

① Press ◀ or ▶ to select 2.



② Press ▼ to move to menu item.



③ Press ▲ or ▼ to select [言語/LANG.].



④ Press ►.  
See “1 [言語/LANG.] screen appears when turning the camera on.” (→p.22).

# Taking Pictures ( **AUTO** AUTO Mode)

This section describes the basic operations.

## 1 Turn the camera on.

- ① Slide the ON/OFF switch.

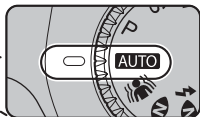
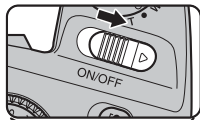

- ② Set the Mode dial to **AUTO**.

### CHECK

Select  Macro mode to take close-up shots (→p.65).

## 2 Press the Flash pop-up button to pop-up the flash.

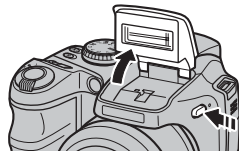

## 3 Switch the display.

Press the EVF/LCD to alternate the display between the viewfinder (EVF) and the LCD monitor.

When the AF frame in the viewfinder (EVF) is difficult to see, adjust the viewfinder using the Diopter adjustment dial.

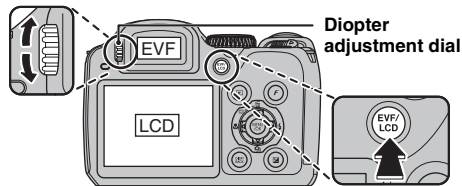

### MEMO

The EVF/LCD selection is retained even when the camera is off or the mode setting is changed.

### Holding the camera correctly

Brace your elbows against your sides and hold the camera with both hands.

Using the viewfinder (EVF) allows for a steady arm position, preventing picture blur.

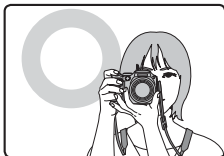
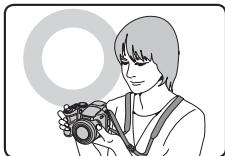

Do not cover the lens or flash with your fingers, and be careful not to touch the autofocus ring.

### CAUTION

- Moving the camera while shooting gives a blurred picture (camera shake). Hold the camera steadily with both hands.
- If the lens or flash is obscured by your fingers or the strap, or if the autofocus ring is touched when shooting, subjects may be out of focus or the brightness (exposure) of your shot may be incorrect.
- When the autofocus ring is held during operation, a warning message [ZOOM ERROR] is displayed. Then the lens will automatically refocus.

## 4 Focus on the main subject in the AF frame and press the shutter button halfway.



AF frame



Halfway pressed

AF frame becomes smaller and camera focuses on the subject.

### CHECK

- **Focus on the subject**  
Double beep is heard  
Indicator lamp lit green
- **Not focus on the subject**  
No sound  
AF frame lit red  
**!AF** indicated  
Indicator lamp blinking green

### MEMO

- The shutter button has a halfway point at which focus and exposure are automatically optimized before taking the picture by pressing fully down.
- When pressing the shutter button halfway, a lens operation sound may be heard.

Continued →

## 5 Press the shutter button fully.

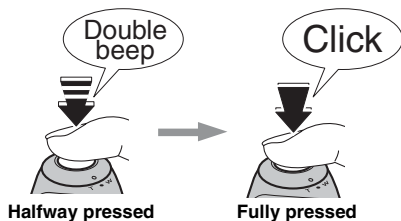

### ! CAUTION

When taking a picture using the flash, the image may disappear and go dark briefly due to flash charging. The indicator lamp blinks orange during charging.

### MEMO

- When the subject is not in the AF frame, use AF/AE lock to take the picture (→p.33).
- When pressing the shutter button down fully in one motion, the camera takes the picture without the AF frame changing.

### Flash



When pressing the shutter button down halfway, **[Flash Icon]** appears on the screen before the flash fires.

If you want to change the setting, see p.66 for information on flash.

### ! CAUTION

- The image shown on the screen before the picture is taken may differ in brightness, color, etc. from the image actually recorded. Play back the recorded image to check it (→p.37).
- When selecting a slow shutter speed that will cause camera shake, **[Shake Icon]** appears on the screen. Use flash or a tripod.
- See p.140-143 for information on warning displays. See "Troubleshooting" (→p.144-149) for more information.

## Indicator lamp display

The indicator lamp lights or blinks when pressing the shutter button, etc. The indicator lamp shows the camera status.

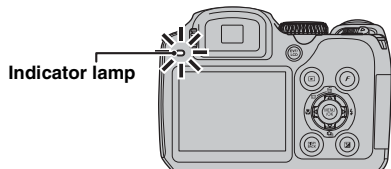

Display	Status
Lit green	Locking the focus
Blinking green	Camera shake warning, AF warning, or AE warning (ready to shoot)
Blinking green and orange alternately	Recording to Memory Card or internal memory (ready to shoot)
Lit orange	Recording to Memory Card or internal memory (not ready)
Blinking orange	Charging flash (flash will not fire)
Blinking red	<ul style="list-style-type: none"> <li>Warnings for Memory Card and internal memory</li> <li>Card not formatted, incorrect format, memory full, Memory Card or internal memory error</li> <li>Lens operation error</li> </ul>

### MEMO

Detailed warning messages appear on the screen (→p.140-143).

## Using Intelligent Face Detection when taking pictures

Intelligent Face Detection allows you to focus on and adjust the brightness of people's faces. Intelligent Face Detection is effective with the camera held horizontally or vertically.



To use Intelligent Face Detection, follow the below steps.

**Available Shooting modes:** **AUTO**, **[[M]]**, **[N]**, **[P]**, **[S]**, **[M]**, **[A]**, **[S]**, **[P]**

### 1 Press .

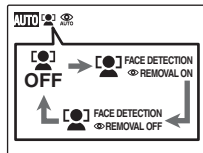
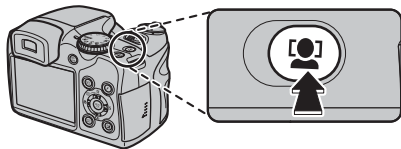
Intelligent Face Detection setting changes each time you press .



Red-eye effect, caused by the light of the flash reflecting off the inside of the eye, will be corrected automatically when a picture is taken with [  FACE DETECTION  REMOVAL ON ] set.

**Continued** ➔

**!** CAUTION

- If the camera is unable to detect faces in an image, it will not correct the red-eye effect sufficiently, or not at all.
- Correction results may differ depending on the scene.
- The processing may take more time if there are many faces in an image.

**2** Check the composition on the LCD monitor.



Green frame

When there are multiple people in the frame, Intelligent Face Detection will set a green frame around the face nearest to the center of the picture. This face has focusing priority.

**3** Press the shutter button down fully to take pictures.



**✓** CHECK [ **FACE DETECTION** **REMOVAL ON** ]

When a picture is taken with [ **FACE DETECTION** **REMOVAL ON** ] set, the red-eye effect will be detected and corrected before the image is recorded.



① Red-eye effect in an image will be detected after the shooting.



② Red-eye effect will be corrected before the image is recorded. When the red-eye effect is not detected, processing will end without the [REMOVING] screen displayed.

**Subjects not suitable for Intelligent Face Detection**

Intelligent Face Detection automatically focuses on a face(s). However, difficulties will occur with the Intelligent Face Detection mode in the following situations:

- The face is obscured by glasses, sunglasses, a hat or hair.
- A person turned sideways, or who has their head tilted
- The subject is too far away to recognize a face

Intelligent Face Detection will not work in cases where the subject is standing on his/her head, is not a person (pet or other animal), or if the camera is not held correctly.

**Use AF/AE lock (→p.32) to guarantee best result when shooting a subject that is not suited for Intelligent Face Detection.**

**! CAUTION**

- If the camera or subject move as the picture is taken, the subject's face may move out of the Intelligent Face Detection frame.
- When the camera is detecting multiple faces, the green frame is set around the face near the center. If you want to focus on another subject, move the camera so that the new subject is in the center of the screen. If focus is still not achieved, press  (Intelligent Face Detection) to turn off the function, and take the picture using AF/AE lock (→p.33). Intelligent Face Detection can focus on a face in a white frame providing the subjects in the green and white frame are of the same focal length.
- Pressing the shutter button halfway with Intelligent Face Detection off, the focus will be on the center of the frame.



**Using the Dual Image Stabilizer function when taking pictures**

You can reduce camera shake by using the Dual Image Stabilizer function.

**MEMO**

When **AUTO** or  Picture Stabilization is selected for the shooting mode, both camera shake and blurring of moving subjects can be reduced.

**Available Shooting modes: All**

- 1 Press  to activate Dual IS (image stabilization) mode. Press  again to set Dual IS mode OFF.

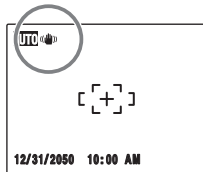
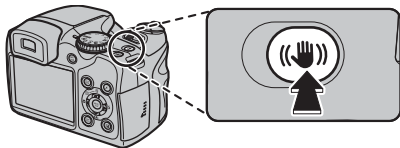

 will be displayed when Dual IS mode is activated.

**Continued** ➔



- ② Press the shutter button down fully to take pictures.

**CAUTION**

Camera shake and blurring may remain depending on scenes.

**Taking pictures with the focus and exposure locked**



In the above composition, the subjects are not in the AF frame. Pressing the shutter button halfway at this point will result in the subjects being out of focus.

**AF/AE lock is useful:**

Use AF/AE lock to guarantee best result when shooting a subject that is not suited to autofocus (→p.34).

**CAUTION**

When taking a picture in AF/AE lock, cancel  Intelligent Face Detection.



## Using AF/AE lock

- 1** Move the camera slightly so that one of the subjects is in the AF frame.



- 2** Press the shutter button down halfway to focus on the subject.



Halfway pressed



- 3** Continue to hold the shutter button down halfway. Move the camera back to the original image and press the shutter button fully.



Fully pressed

### MEMO

- AF/AE lock can be applied repeatedly before the shutter is released.
- On FinePix S8100fd, pressing the shutter button down halfway locks the focus and exposure settings (AF and AE lock).

**Continued** ➔

### **Subjects not suitable for autofocus**

FinePix S8100fd uses a high-precision autofocus mechanism. However, it may have difficulty focusing on the following:



**Very shiny subjects such as a mirror or car body**

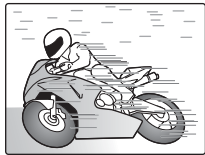

**Fast moving subjects**

- Subjects photographed through glass
- Subjects that do not reflect well, such as hair or fur
- Subjects with no substance, such as smoke or flames
- Dark subjects
- Subjects with little or no contrast between the subject and the background (such as subjects dressed in the same color as the background)
- Shots where another high-contrast object (not the subject) is close to the AF frame and is either closer or further away than your subject (such as a shot of someone against a background with strongly contrasting elements)

For such subjects use AF/AE lock (→p.33) or "MF" Manual focus mode (→p.84).





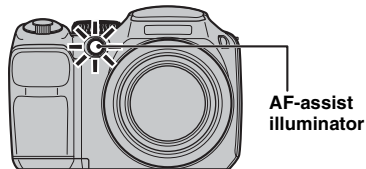

### **AF-assist illuminator**

Use this illuminator to focus on the subject in dimly lit conditions.

When pressing the shutter button down halfway, the camera fires the AF-assist illuminator (orange) while focusing on your subject.



### **MEMO**

- Even when the AF-assist illuminator fires, the camera may have difficulty focusing in some conditions.
- Even though there is no danger to safety, do not expose it directly in someone's eyes.
- When using the AF-assist illuminator in Macro mode, the camera may have difficulty focusing to take close-up shots.
- See p.111, 112 for information on turning the AF-assist illuminator off.
- AF-assist illuminator does not fire in , , , , , , or  mode.

## Using zoom function

Use the zoom lever to take pictures with zoom function. The zoom bar appears on the screen while the zoom lever is being used. Use digital zoom when you want to shoot the subject closer (→p.112, 116).

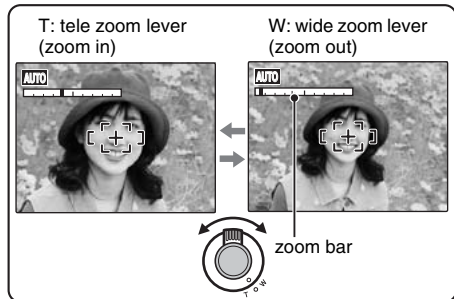

## Adjusting the shot composition

### Select the screen display.

Press DISP/BACK to change the screen display.

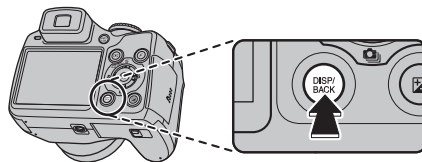

Text displayed



No text displayed



Post shot assist window displayed



Framing guideline displayed

**Continued** →

## Best framing

Position the main subject at the intersection of two lines in this frame or align one of the horizontal lines with the horizon. Use this frame as a guide to the subject's size and the balance of the shot while composing a shot.



### MEMO

Always use AF/AE lock when composing a shot. The image may be out of focus if AF/AE lock is not used.

## Post shot assist window

Up to the last 3 photographed images appear on the post shot assist window. This serves as a guide for taking other shots with similar compositions.



## Format of post shot assist window

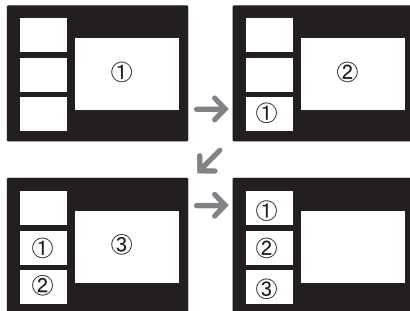



# Viewing the Images

Playback your images to check them. For important photographs, always take a test shot and view the image to make sure that the camera is working normally.

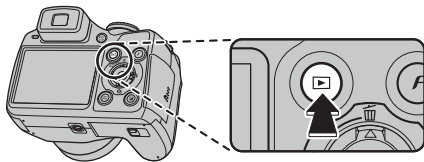

## Setting the camera to Playback mode

Press  during shooting to change to Playback mode.



When the camera is off, press  for about 1 second to turn the camera on in Playback mode.

### MEMO

- Press  to play back the last shot.
- When playing back images shot with a camera other than FinePix S8100fd,  a present icon appears on the screen.

### CAUTION Still images viewable on FinePix S8100fd

This camera will display still images recorded on FinePix S8100fd or still images (excluding some uncompressed images) recorded on any FUJIFILM digital camera that supports **xD-Picture Cards** or SD Memory Cards. Clear playback or playback zooming may not be possible for still images shot on cameras other than FinePix S8100fd.

## Select the screen display.

Press DISP/BACK during Playback mode to change the screen display.

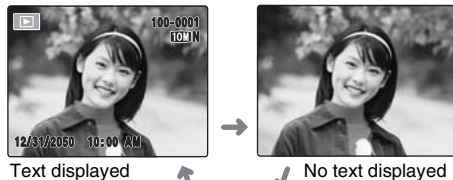
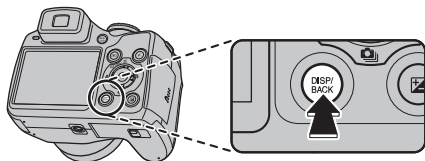

Sorting by date

## Single-frame playback



To select the required image:

Press ◀: last image

Press ▶: next image

### Selecting images quickly

To select images quickly, hold down ◀ or ▶ for 1 second during playback.

When releasing ◀ or ▶, camera returns to single-frame playback.

## Playback zoom

### 1 Zoom in / Zoom out.

To zoom in an image during single-frame playback:

**W:** wide zoom lever  
(zoom out)

**T:** tele zoom lever  
(zoom in)

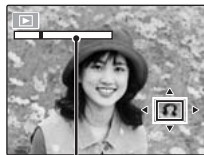

Zoom bar



Turn to W or T to zoom in or out of an image.

## 2 Display another part of the image.



Navigation screen  
(Current displayed  
image)



Press ▲, ▼, ◀, or ▶ to display another part of the image.

### MEMO

- Zoom cannot be performed when the images recorded by **OSM** are played back.
- Press DISP/BACK to cancel playback zoom.

## Sorting by date

In sorting by date mode, you can view all images taken on the same day.

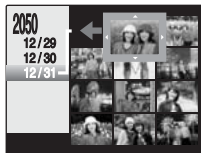

① Press ▲, ▼, ◀, or ▶ to move the cursor (colored frame) to the selecting frame.



② Press MENU/OK to enlarge the image.

**Continued** ➡

## Selecting the date



- ① Press ▲, ▼, ◀, or ▶ to move the cursor (colored frame) to ◀ on the upper left frame.



- ② Press ◀ to display the selecting date.



- ③ Press ▲ or ▼ to move the cursor (colored frame) to select the date. Press ▲ or ▼ repeatedly to jump to the next page.



- ④ Press ▶.

## Multi-frame playback

Use this function to display a single frame, 2 frames, 9 frames or 100 frames (Micro Thumbnail). You can compare and select images using the Multi-frame display. Use the zoom lever to change the display.

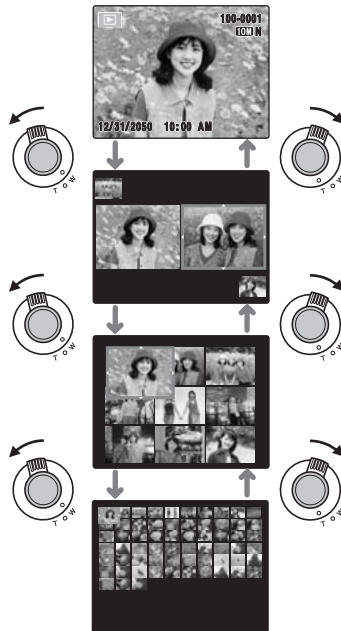



## 2 frames playback



- 1 Press ▲, ▼, ◀ or ▶ to select the images you want to compare (such as the images taken in [📷 NATURAL & 📷] mode).



- 2 Press MENU/OK to enlarge the image.

## 9 frames playback/100 frames playback (Micro thumbnails playback)



- 1 Press ▲, ▼, ◀ or ▶ to change the colored frame and select an image. Press ▲ or ▼ repeatedly to jump to the next page.



- 2 Press MENU/OK to enlarge the image.

## Using Intelligent Face Detection when playing back pictures

You can display and enlarge the faces in images when playing back the images shot using the Intelligent Face Detection function (👤 is displayed) (→p.29).



- 1 Press 👤, then the frame(s) appears on the detected face(s) in pictures.



- 2 The detected face(s) is enlarged each time you press 👤.



- 3 Press ▲, ▼, ◀, or ▶ to display another part of the image (→p.38).

### ! CAUTION

The images recorded by 📷 cannot be enlarged.



### MEMO

Press DISP/BACK to return to normal playback.





Playback mode allows you to erase unnecessary images or movies to have ample free space on the Memory Card or internal memory.

Your camera calls images “frames”.

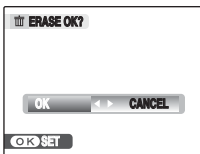
## Using the erase button (/▲)







Pressing  (▲) erases images easily.

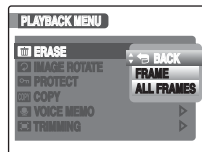

-  ① Press ◀ or ▶ to select the erasing image.
-  ② Press  (▲).
-  ③ Press ◀ or ▶ to select [OK].
-  ④ Press MENU/OK to erase the displayed image.

## Erasing the images using [PLAYBACK MENU]

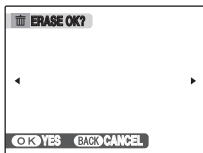

-  ① Press MENU/OK to open the [PLAYBACK MENU].
-  ② Press ▲ or ▼ to select [ ERASE].
-  ③ Press ▶.
-  ④ Press ▲ or ▼ to select [FRAME] or [ALL FRAMES].
-  ⑤ Press MENU/OK to confirm the setting.

**Erasing one frame at a time ([FRAME])**

① Press ◀ or ▶ to select the erasing frame (file).



② Press MENU/OK to erase the currently displayed frame (file).

**MEMO**

To erase another frame (file), repeat above steps. When erasing frames (files) is completed, press DISP/BACK.

**CAUTION**

Pressing MENU/OK repeatedly erases consecutive frames (files). Take care not to erase a frame (file) by mistake.

**Erasing all frames ([ALL FRAMES])**

① Press ◀ or ▶ to select [OK].

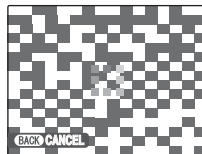

② Press MENU/OK to erase all the frames (files).

**MEMO**

Press DISP/BACK to cancel erasing of all the frames (files). Some unprotected frames (files) will be left unerased.

**Continued** ➔

**MEMO**

- When using a Memory Card, the images in the Memory Card are erased. When not using a Memory Card, the images in the internal memory are erased.
- Protected frames (files) cannot be erased. Unprotect the frames (files) before erasing them (→p.97).
- [DPOF SPECIFIED. ERASE OK?] or [DPOF SPECIFIED. ERASE ALL OK?] appears, when erasing DPOF specified files is attempted.

**CAUTION**

Erased frames (files) cannot be recovered. Back up important frames (files) onto your PC or another media.

# Using the Shooting Functions — Procedure of Setting

Specify the camera settings for taking pictures to get the best result. A general guide is given below.

## 1 Select a Shooting mode.

Turn the Mode dial to select a Shooting mode. The camera settings are tailored to the scene being shot.

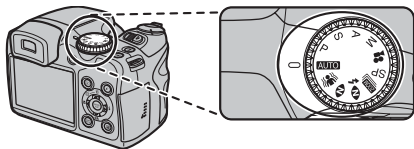

### ! CAUTION

When you have been used for long periods in places subject to extreme temperature rises, it will lower your image quality and streaking may also be visible in your images. If this occurs, turn the camera off several times to prevent heating the camera.

[AUTO] AUTO	This is the easiest mode for taking pictures (→p.49).
[PICTURE STABILIZATION]	Used for selecting a fast shutter speed that reduces camera shake and moving-subject blurring (→p.49).
[NATURAL LIGHT]	This mode produces beautiful images that retain the natural ambience when shots are taken in low-light conditions (→p.50).
[NATURAL & ]	This mode shoots 2 images continuously without flash and with flash. Shooting with flash allows you to take a picture of a main subject brightly. This mode is useful for shooting 2 different types of pictures at the same time (→p.50).
[ZOOM BRACKETING]	[ZOOM BRACKETING] allows you to take 3 images in one shot with a full frame and two cropped frames (1.4x and 2x zoom) by pressing the shutter button just one time (→p.51).
[SP SCENE POSITION]	Use to select the ideal setting from Scene position menu for the shot. (→p.52).
[M MANUAL]	All manual settings for taking pictures (→p.61).
[A APERTURE-PRIORITY AE] [S SHUTTER-PRIORITY AE] [P PROGRAM AE]	Used for changing the aperture or shutter speed setting so that the action is frozen, the flow of the motion is conveyed, or the background is out of focus (→p.56-59).
[MOVIE]	Use for shooting movies (→p.105).

Continued ➔

## 2 Specify the Shooting settings.

Pressing buttons or selecting menu allows you to specify Shooting functions. You can obtain the best result for shooting.

### ■ Specifying functions using buttons

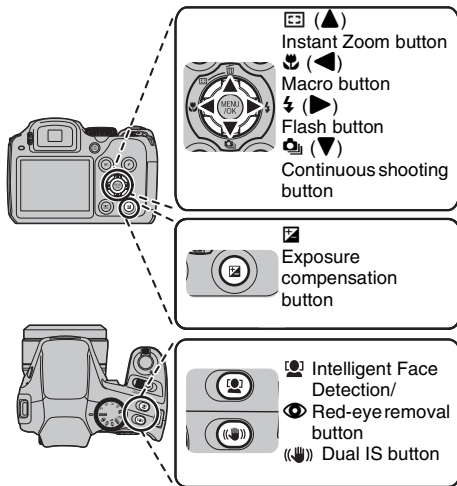

<input type="checkbox"/> Instant Zoom	Instant Zoom allows you to decide how to frame a picture while seeing the area around your subject on the screen. Instant Zoom is also quicker to zoom than optical zoom (→p.71).
<input type="checkbox"/> Macro	Used for close-up shots (→p.65).
<input type="checkbox"/> Flash	Used for shots in dark locations or for backlit subjects, etc. (→p.66).
<input type="checkbox"/> Continuous shooting	Used to take a series of continuous shots or to use auto bracketing (with exposure compensation) (→p.68).
<input checked="" type="checkbox"/> Exposure compensation	Used for changing the image brightness (→p.63).
<input type="checkbox"/> Intelligent Face Detection/ <input type="checkbox"/> Red-eye removal	Pressing this button allows you to focus on people's faces. Also, red-eye effect, caused by the light of the flash reflecting off the inside of the eye, can be corrected before an image is recorded. (→p.29).
<input type="checkbox"/> Dual IS mode	Reduces camera shake and moving subject blurring (→p.31).

■ Specifying functions using [**F-MODE MENU**] (**F** button)

Press **F** button to open the [**F-MODE MENU**].

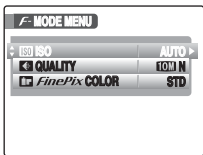
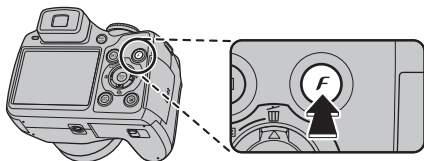

[ISO ISO]	Use to specify required sensitivity setting (→p.76).
[QUALITY]	Use to specify required image size (→p.77).
[FinePix COLOR]	Use to specify required color tone (→p.78).

■ Specifying functions using [**SHOOTING MENU**] (**MENU/OK** button)

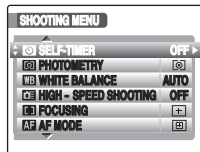
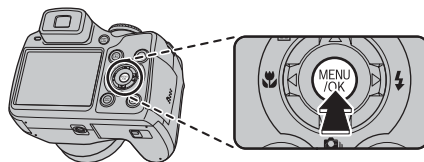

**Continued** ➔

[SCENE POSITION]	Use to select the best setting for the scene being shot. Choose from 13 types of scene (only SP)(→p.52).
[SELF-TIMER]	Used in situations such as group shots where the photographer is included in the shot (→p.79).
[PHOTOMETRY]	Use to select light metering method (only M, A, S, P) (→p.80).
[WB WHITE BALANCE]	Use to adjust the color tone (only M, A, S, P,  ) (→p.81).
[HIGH-SPEED SHOOTING]	Use to focus the shot quickly (→p.83).
[FOCUSING]	Use to specify focusing mode (only M, A, S, P) (→p.83).
[AF AF MODE]	Use to specify focusing area (only M, A, S, P) (→p.85).
[S SHARPNESS]	Use this setting to soften or emphasize the outline and quality of an image (only M, A, S, P) (→p.87).
[FLASH] (Brightness Adjustment)	Use this setting to adjust the amount of light emitted by the flash to suit the photography conditions or to achieve a desired effect (only M, A, S, P) (→p.87).
[BRACKETING]	Use this setting to photograph the same image with different exposure settings (only M, A, S, P) (→p.88).



# Setting the Shooting Mode

You can select the most suitable setting according to the subject by selecting one of the Shooting modes.

## [ **AUTO** AUTO ]

This is the easiest mode for providing crisp and clear shots.

Use this mode for ordinary photography.

Camera specifies all settings other than **F**-MODE ([QUALITY] and [FinePix COLOR]) automatically.

Set the Mode dial to **AUTO**.

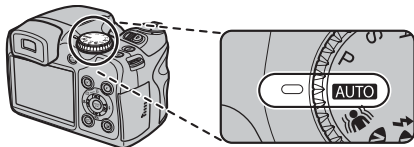

### CHECK

- See p.67 for information on the available flash modes.
- Only [AUTO] can be selected for the [ISO ISO] (sensitivity) setting.

## [ PICTURE STABILIZATION ]

Use this mode to select a fast shutter speed that reduces camera shake and moving-subject blurring.

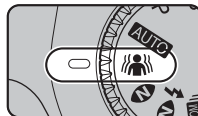

Set the Mode dial to .

### CHECK

- See p.67 for information on the available flash modes.
- Only [AUTO] can be selected for the [ISO ISO] (sensitivity) setting.

## [ NATURAL LIGHT ]

This mode produces beautiful images that retain the natural ambience when shots are taken in low-light conditions.

This mode is also ideal for shooting indoor or situations where the flash cannot be used.

Camera sets the high-sensitivity setting when selecting the Natural light mode. This mode is effective for reducing camera shake and moving-subject blurring when taking pictures in low-light conditions.

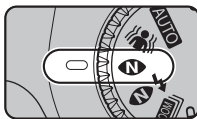

Set the Mode dial to .

### CHECK

- Flash cannot be used in the Natural light mode.
- Only [AUTO] can be selected for the [ISO] ISO (sensitivity) setting.

## [ NATURAL & ]

This mode shoots 2 images continuously without flash and with flash. Shooting with flash allows you to take a picture of a main subject brightly. Shooting without flash produces beautiful images that retain the natural ambience. This mode is useful for shooting 2 different types of pictures at the same time.

① Press the Flash pop-up button to pop up the flash.

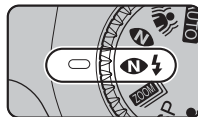

② Set the Mode dial to .

When pressing the shutter button, first picture is taken without flash and next picture is taken with flash.

Always 2 pictures are taken per 1 shot.

Do not move the camera until the shooting ended.

### MEMO

This mode helps to avoid failed shots that may occur when using other Shooting modes when taking a picture against the sun, etc.

### CHECK

- Flash fires automatically. Do not use this mode at situations where the flash cannot be used.
- Only [AUTO] can be selected for the [ISO] ISO (sensitivity) setting.
- When there is insufficient space on the Memory Card or internal memory for 2 shots, a picture cannot be taken.
- Continuous shooting is disabled when setting .

## [ZOOM] ZOOM BRACKETING

[ZOOM] ZOOM BRACKETING allows you to take 3 images in one shot with a full frame and two cropped frames (1.4x and 2x zoom) by pressing the shutter button just one time. You can enjoy both zoomed pictures and a full frame.

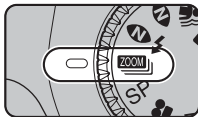

Set the Mode dial to .



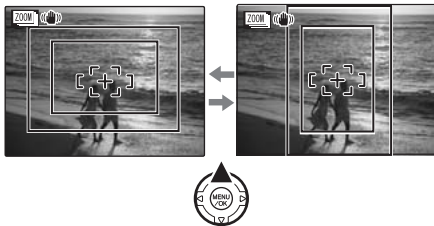

Two boxes appear to show the area that will be enlarged when shooting. The outer box indicates 1.4x zoom and the inner box indicates 2x zoom. Press  to switch between the horizontal and vertical positions.



### CHECK

- See p.67 for information on the available flash modes.
- Only [AUTO] can be selected for the [ISO] ISO (sensitivity) setting.

### MEMO

- [QUALITY] is fixed to .
- The size of the saved images is fixed to  (1x),  (1.4x), and  (2x).
- Digital Zoom cannot be used.
- When the Mode dial is set to  while digital zoom is working, the camera switches to maximum optical zoom scale automatically.
- [Dual IS] is automatically activated when [ZOOM] ZOOM BRACKETING is set.
- Only [TOP 3] can be used among Continuous shooting modes.
- The color of the two boxes can be changed (→p.111, 113).

### *In combination with Intelligent Face Detection*

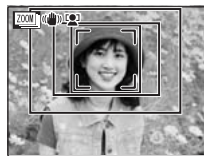

While  Intelligent Face Detection is set, the area to be shot is centered on the detected face in [ZOOM] ZOOM BRACKETING].

### CAUTION

This feature always takes 3 shots. However, if there is insufficient space on the Memory Card or internal memory for 3 shots, no picture will be taken.

## [SP SCENE POSITION]





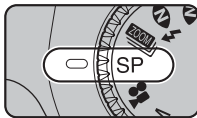



This mode provides the best Scene position setting for the scene being shot. Choose from 13 types of scene.

Select the Scene position setting in the [SCENE POSITION] menu.



Set the Mode dial to SP.

### MEMO

- SP is set to  as factory default setting.
- See p.67 for information on the available flash modes.
- Only [AUTO] can be selected for the [ISO ISO] (sensitivity) setting.
- [CHROME] (→p.78) cannot be set.
- AF-assist illuminator does not fire in , , , , ,  OFF,  and  mode.

## ■ Selecting Scene position setting



① Press MENU/OK to open the menu.



② Press ▲ or ▼ to select [SCENE POSITION].



③ Press ►.













④ Press ▲ or ▼ to select the setting.









⑤ Press MENU/OK to confirm the setting.

## ■ Scene position list







Scene position	Functions
[  <b>PORTRAIT</b> ]	Use this mode for photography to get beautiful skin tones and soft overall tone.
[  <b>LANDSCAPE</b> ]	Use this mode for shooting scenery in daylight and provides crisp, clear shots of scenery such as buildings and mountains.
[  <b>SPORT</b> ]	Use this mode to take pictures of a moving subject. It gives priority to faster shutter speeds. When setting [  <b>SPORT</b> ] mode, the camera sets to [  <b>HIGH-SPEED SHOOTING</b> ] mode (→p.83) automatically.
[  <b>NIGHT</b> ]	Use this mode for shooting evening and night scenes. A picture is taken with a slow shutter of up to 3 seconds.
[  <b>FIREWORKS</b> ]	Use this mode to shoot fireworks. It is effective for taking more vivid shots of fireworks with a slow shutter. Refer to “Selecting the exposure time setting” (→p.55).
[  <b>SUNSET</b> ]	Use this mode to shoot sunset, making the colors more vivid.
[  <b>SNOW</b> ]	Use this mode to prevent darkening images and provide crisp, clear shots, when shooting at snowy scene where the whole screen appears white.
[  <b>BEACH</b> ]	Use this mode to prevent darkening images and provide crisp, clear shots, when shooting at beach under strong sunlight.

**Continued** ➡

## Setting the Shooting Mode

Scene position	Functions
[  <b>MUSEUM</b> ]	Use this mode for taking pictures in places such as museum where the use of flash and making an operation sound and a shutter sound are restricted. Flash mode is forcibly set to Suppressed flash, and operation sound, shutter sound, and self-timer lamp are off.
[  <b>PARTY</b> ]	Use this mode for shooting at indoor wedding and party. This mode produces beautiful images that retain the natural ambience when shots are taken in low-light conditions.
[  <b>FLOWER</b> ]	Use this mode to take clear close-up shots when zooming up a flower. It is effective for taking more vivid shots of flower petal.
[  <b>TEXT</b> ]	Use this mode to shoot documents and white board. It is effective for taking clearer shots.
[  <b>AUCTION MODE</b> ]	This mode is suitable for shooting pictures for a web auction. You can record 1 to 4 shots as a single image. It is convenient for showing items at various angles for web auctioning. See p.55 for setting a frame for [  <b>AUCTION MODE</b> ].

### CHECK

- Use a tripod to prevent camera shake for [  **NIGHT**] and [  **FIREWORKS**], as a slow shutter speed is used.
- Check whether photography is permitted before using [  **MUSEUM**] mode.
- When setting  or  mode, the camera sets to  Macro mode automatically.

## ■ Selecting the exposure time setting for [ FIRE WORKS ]

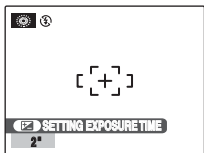

① Press  to open the setting screen.



② Press  or  to select the exposure time.

## ■ Setting frame for [ AUCTION MODE ]

You can select 4 types of frames:



① Select [  AUCTION MODE ] from the [SHOOTING MENU].



② Press  to show a frame selecting display.





③ Press  or  to select the frame.



④ Press MENU/OK to confirm the setting.

### CHECK

- The images are resize to **08M**.
- Intelligent face detection (→p.29) cannot be used.
- When  appears in the LCD screen, the [  AUCTION MODE ] cannot be used.

## [P PROGRAM AE]





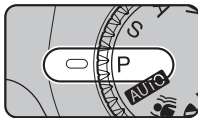

This is an automatic mode to specify the settings except for the shutter speed and aperture setting.

This is a simple way to take pictures the same as the A Aperture-priority Auto and S Shutter-priority Auto modes (Program shift).



Set the Mode dial to P.

Shooting functions:

-  PHOTOMETRY] (→p.80)
-  [WB WHITE BALANCE] (→p.81)
-  [L FOCUSING] (→p.83)
-  [AF AF MODE] (→p.85)
-  [S SHARPNESS] (→p.87)
-  [FLASH] (→p.87)
-  [BRACKETING] (→p.88)

### CHECK

See p.67 for information on the available flash modes.

### Program shift

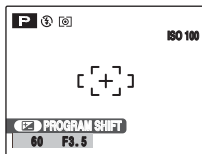

① Press  to open the setting screen.



② Select different shutter speed and aperture setting combinations without changing the exposure setting.



③ Press the shutter button to take pictures.



### MEMO

- Program shift can be used when Suppressed flash (→p.67) is set in flash mode.
- The shutter speed and aperture setting appear in yellow when the camera is in Program shift mode.
- Any of following cancels Program shift:
  - Changing the Mode dial setting
  - Setting the camera to Playback mode
  - Turning the camera off
  - Popping the flash up



### CAUTION

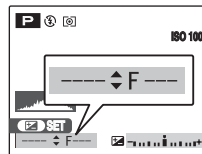

When the brightness of the subject is outside the camera's brightness metering range, [---] appears as the shutter speed and aperture setting on the screen.







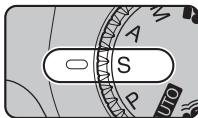

## [S SHUTTER PRIORITY AE]

This is an automatic mode to set the shutter speed. Use this mode to freeze a moving subject (fast shutter speed) or convey the impression of movement (slow shutter speed).



Set the Mode dial to S.

Shooting functions:

-  PHOTOMETRY] (→p.80)
-  WHITE BALANCE] (→p.81)
-  FOCUSING] (→p.83)
-  AF MODE] (→p.85)
-  SHARPNESS] (→p.87)
-  FLASH] (→p.87)
-  BRACKETING] (→p.88)

### CHECK

See p.67 for information on the available flash modes.

## ■ Setting the shutter speed

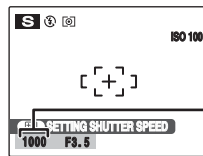

Shutter speed



① Press  to open the setting screen.



② Press  or  to select the shutter speed.



③ Press the shutter button to take pictures.

**Continued** 

**!** CAUTION

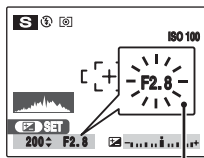

Lit red

When the correct exposure cannot be obtained with selected shutter speed, the aperture setting appears in red. When this occurs, adjust the shutter speed again.

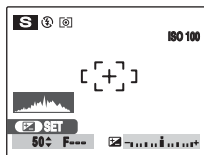

When the brightness of the subject is outside the camera's brightness metering range, [F---] appears as the aperture setting. When this occurs, press the shutter button down halfway to measure the light level again.

**Shutter speed**

When shooting a moving subject, you can either “freeze the motion” or “capture the sense of movement” by adjusting the shutter speed.



Freezes the motion of the subject.



Photographs the traces left by the subject's movement.

## ⬡ [A APERTURE PRIORITY AE]

This is an automatic mode to set the aperture. Use this mode to have the area in front of and behind the subject out of focus (large aperture) or have both near and far subjects in focus (small aperture).

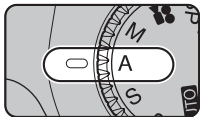

Set the Mode dial to A.

Shooting functions:

- [M] PHOTOMETRY] (→p.80)
- [WB] WHITE BALANCE] (→p.81)
- [L] FOCUSING] (→p.83)
- [AF] AF MODE] (→p.85)
- [S] SHARPNESS] (→p.87)
- [FLASH] FLASH] (→p.87)
- [BRACKETING] BRACKETING] (→p.88)

### ✓ CHECK

See p.67 for information on the available flash modes.

## ■ Setting the aperture

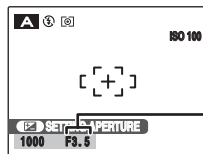



Aperture



① Press  to open the setting screen.



② Press  or  to select the aperture.



③ Press the shutter button to take pictures.

**Continued** ➔

**!** CAUTION

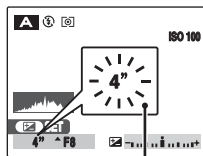

Lit red

When the correct exposure cannot be obtained with selected aperture setting, the shutter speed appears in red. When this occurs, adjust the aperture setting again. When [FORCED FLASH] is set, you can take a picture with a shutter speed of up to 1/45 sec.

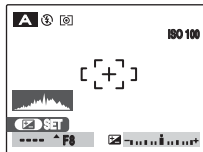

When the brightness of the subject is outside the camera's brightness metering range, [----] appears as the shutter speed.

**Aperture**

By adjusting the aperture, you can change the depth of focus (depth of field). Selecting a larger number of aperture (closed) obtains a larger depth of focus. Selecting a smaller number of aperture (open) has the area in front of and behind the subject out of focus.

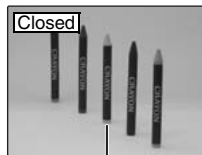

Main subject

The area in front of and behind the subject is also in focus in the shot.

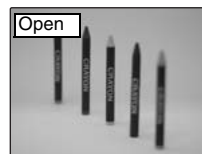

The area in front of and behind the subject is out of focus.

## [M MANUAL]

This is a shooting mode that allows for settings including the shutter speed and aperture.

Set the Shooting functions to manual to easily control yourself.

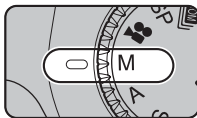

Set the Mode dial to M.

Shooting functions:

- [M] PHOTOMETRY] (→p.80)
- [WB] WHITE BALANCE] (→p.81)
- [F] FOCUSING] (→p.83)
- [AF] AF MODE] (→p.85)
- [S] SHARPNESS] (→p.87)
- [FLASH] (→p.87)
- [BRACKETING] (→p.88)

### ✓ CHECK

See p.67 for information on the available flash modes.

## ■ Setting the shutter speed

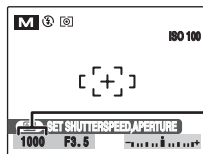

① Press to open the setting screen.



② Press or to select the shutter speed.



③ Press the shutter button to take pictures.

### 📄 MEMO

- Use a tripod to prevent camera shake.
- In shots with long exposures, noise (dots) may appear on the image.

### ! CAUTION

If the shutter speed is set to a speed 1/1000 sec., smearing (white stripes) may appear in the image (→p.156).

**Continued** ➔

## ■ Setting the aperture

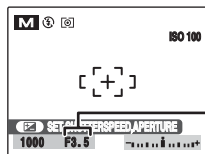



Aperture



① Press  to open the setting screen.



② Press  or  to select the aperture.



③ Press the shutter button to take pictures.

### ***The exposure indicator***

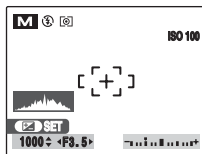

Use the exposure indicator on the screen as a guide when setting the exposure. When the brightness of the subject is outside the camera's brightness metering range, the exposure indicator disappears on the screen.

# Adjusting the Image Brightness ( Exposure Compensation)

Use this menu for shots to get the correct brightness (exposure), such as shots with extremely high contrast between the subject and the background.

Available Shooting modes: A, S, P, 

## Adjusting exposure compensation

Press  to display the exposure compensation setting screen.

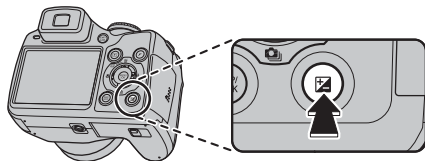





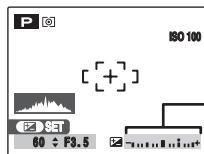



### CAUTION

This function can only be used for A, S, P, or  in Shooting mode.



Exposure Compensation indicator

-  ① Press  to open the setting screen.
-  ② Press  or  to set the compensation value.
-  ③ Press  to confirm the setting.
-  ④ Press the shutter button to take pictures.



### CHECK

- The symbol indicating the compensation direction (– or +) turns yellow.
- The  icon also turns yellow while exposure compensation is being set and then turns blue after setting is completed.
- The screen brightness will increase or decrease depending on the exposure compensation setting.

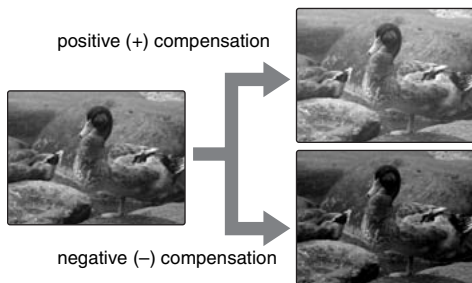
*Continued* 



 **MEMO**

- This setting is retained when the mode is changed or the camera is turned off (☑ icon appears). Set the exposure compensation to "0" unless compensation is required.
- Any of the following disables exposure compensation:
  - Using the flash in [AUTO] or  mode
  - Shooting dark scenes in  or  mode

**Guide to compensation**

- Backlit portraits: +2 steps to +4 steps (+2/3 EV to +1 1/3 EV)



- Very bright scenes (such as snowfields) and highly reflective subjects: +3 steps (+1 EV)











- Shots made up predominantly of sky: +3 steps (+1 EV)
- Spotlit subjects, particularly against dark backgrounds: -2 steps (-2/3 EV)
- Scenes with low reflectivity, such as shots of pine trees or dark foliage: -2 steps (-2/3 EV)



\* See Explanation of Terms: "EV" (→p.156).





# Macro/Super Macro (Close-up)



Use this mode to take close-up shots.

**Available Shooting modes:** **AUTO**, , , , , , SP (, , ), M, A, S, P

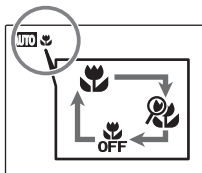
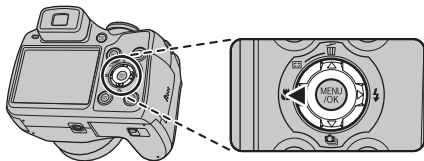

Press  () to select Macro mode.

The Macro mode setting changes each time you press the  () .





 or  appears on the screen indicating that you can take close-up shots.

## ! CAUTION

- When Super Macro is set, focal length is fixed to 60 mm (35 mm camera equivalent). Zoom function is not available.
- When Super macro is set, flash cannot be used.
- When , , or  is selected, Super macro cannot be used.

## MEMO

- Use a tripod to prevent camera shake in Macro mode.
- Any of the following cancels Macro mode:
  - Changing the Mode dial to SP or 
  - Turning the camera off
- If the flash is too bright, use flash brightness adjustment (→P.87).
- Even if [] MULTI] (→p.85) in the [] AF MODE] is set, the camera focuses near the center of the screen.
- AF-assist may not function correctly if the camera is up close to the subject, such as in macro-mode.

## ⚡ Setting the Flash (Intelligent Flash)

Flash photography is useful for taking pictures at night or indoor dark locations. Choose from 6 flash modes according to the type of shot. See p.67 for information on the available Shooting modes.

### MEMO

By calculating subject distance and brightness, the camera automatically adjusts the flash amount and sensitivity to suit shooting conditions. This maintains consistent balance of bright/dark areas across the image in low-light conditions (dimly-lit room, etc). The Intelligent Flash feature guarantees consistent results when using the flash.

### ! CAUTION Notes on using flash

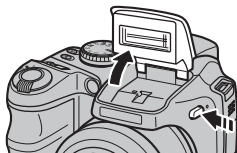

- If the shutter speed is set to a speed faster than 1/1000 sec., the image may appear dark even if the flash is used.
- If pressing the shutter button while the flash is charging (indicator lamp blinking orange), the picture will be taken without the flash (when using [AUTO] and ).
- The flash charging time may increase when the batteries are low on charge.
- When taking a picture using the flash, the image may disappear and go dark briefly due to flash charging. The indicator lamp blinks orange during charging.
- The flash fires several times (pre-flashes and the main flash). Do not move the camera until the picture is taken.

### 1 Press the Flash pop-up button to pop up the flash.

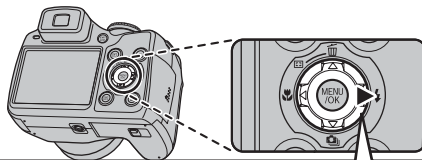

### 2 Select the flash mode setting.



 The flash setting changes each time you press .

 When [  FACE DETECTION  REMOVAL ON ] is set.

### MEMO

When pressing the shutter button down halfway,  appears on the screen before the flash fires.

### [AUTO AUTO FLASH] (not displayed)

Use this mode for ordinary photography.  
The flash fires as required by the shooting conditions.

### [AUTO RED EYE REDUCTION]

This mode is suitable for shooting portraits in low-light conditions.

Use this mode to minimize red-eye (eyes appear in red in the finished photo).



## MEMO Red-eye effect

When using the flash to take a picture of people in low-light conditions, their eyes sometimes appear red in the picture. This is caused by the light of the flash reflecting off the inside of the eye.

### [**⚡ FORCED FLASH**], [**⦿ FORCED FLASH**]

Use this mode in backlit scenes, or to get the correct colors when taking a picture under bright lighting. In this mode, the flash fires in bright as well as dark conditions. Using **⦿** synchronizes Red-eye reduction mode.

### [**S⚡ SLOW SYNCHRO**], [**SLOW RED EYE & SLOW**]

This mode allows you to take pictures of people at night that clearly show both your subjects and the night time backdrop. To prevent camera shake, always use a tripod. Using **S** synchronizes Red-eye reduction mode. Using **⌚** selects slow shutter speeds of up to 3 seconds.

## ! CAUTION

In bright scenes, overexposure may occur.

## Suppressed flash

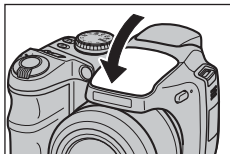

Pressing the flash down changes the camera to Suppressed flash mode. This mode is suitable for situations where the flash cannot be used. Use a tripod to prevent camera shake when shooting in Suppressed flash mode in the dark condition.

## Available flash modes in Shooting modes

Available flash modes in each Shooting mode are listed below.





	[FACE DETECTION REMOVAL OFF]			[FACE DETECTION REMOVAL ON]		
	OFF					
	AUTO	⚡	S⚡	⦿	⦿	⦿
<b>AUTO</b>	✓	✓		✓	✓	
	✓	✓		✓	✓	
<b>N</b>						
<b>⦿</b>		✓			✓	
<b>⦿</b>	✓	✓		✓	✓	
	✓	✓	✓	✓	✓	✓
	✓	✓				
			✓			✓
		✓			✓	
	✓	✓		✓	✓	
	✓	✓		✓	✓	
<b>OFF</b>						
	✓			✓		
<b>TEXT</b>		✓				
	✓		✓			
<b>M</b>		✓			✓	
<b>A</b>		✓	✓		✓	✓
<b>S</b>		✓			✓	
<b>P</b>	✓	✓	✓	✓	✓	✓

## Taking pictures continuously

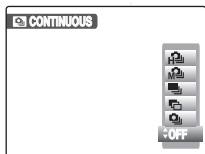
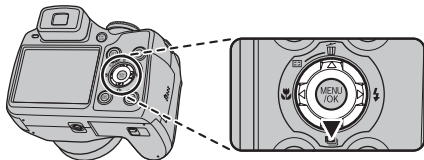
Use this mode to take pictures of a moving subject.

- ① Press  (▼) to display the continuous shooting setting screen.



- [ TOP 33 **3M**] : Ultra high speed continuous shooting  
[ TOP 33 **5M**] : High speed continuous shooting  
[ LONG PERIOD] : Long period continuous shooting  
[ BRACKETING] : Auto bracketing  
[ TOP 3] : Continuous shooting





- ② Press ▲ or ▼ to select a Continuous shooting mode.



- ③ Press MENU/OK to confirm the setting.

### ! CAUTION

- Shooting continues as long as holding the shutter button down. In [BRACKETING] however, just press the shutter button once to shoot 3 frames.
- Number of available frames is limited depending on the available space on the Memory Card or internal memory. When [BRACKETING], if there is insufficient space on the Memory Card or internal memory to record 3 frames, no pictures are taken.
- The focus is determined in the first frame and cannot be changed in mid-sequence (except for [LONG PERIOD]).
- The exposure is determined in the first frame, but in [LONG PERIOD] continuous shooting the exposure is adjusted for the scene being shot.
- The speed of continuous shooting varies depending on the shutter speed.
- The flash cannot be used as the flash mode is set to Suppressed flash. However, when the mode is changed back to normal photography, the flash setting specified before continuous shooting was selected is restored.
- For [TOP 3] continuous shooting and [BRACKETING], the results are always displayed after you shoot. Note that pictures taken using [LONG PERIOD] continuous shooting are recorded without displaying the results.
- In [LONG PERIOD] continuous shooting mode, only 1 frame can be shot when using the [LONG PERIOD] continuous shooting mode and Self-timer mode together.
- Continuous shooting cannot be selected in [ NATURAL &  ] and  .
- File recording time using [TOP3] or [BRACKETING] may increase when record to a Memory Card or internal memory.

## [] TOP 3] continuous shooting

Available Shooting modes: All (except for and )



Shooting continues as long as holding the shutter button down. This mode shoots up to 3 frames.

## [] BRACKETING]

Available Shooting modes: M, A, S, P



This mode shoots the same image with different exposure settings.

Bracketing shoots 3 continuous frames, each with a different exposure setting. **A** is correctly exposed, **B** is overexposed and **C** is underexposed.

The exposure range settings can be changed in [] BRACKETING] in the [SHOOTING MENU].

### ! CAUTION

- If the underexposed or overexposed frame is outside the camera's control range, the picture is not taken with the specified setting increments.
- This function can only be used for M, A, S or P in Shooting mode.

### MEMO Changing the setting (exposure range)

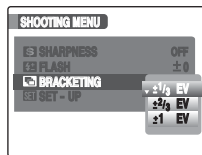

Press the MENU/OK to display the menu and change the setting in the [] BRACKETING] menu option (→p.88).

**Continued** ➔

## [] LONG PERIOD] continuous shooting

**Available Shooting modes:** All (except for , and )

Shooting continues as long as the shutter button is held down. This mode shoots up to Memory Card or internal memory end.

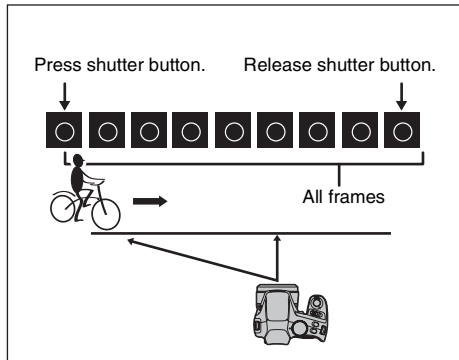

### MEMO

Continuous shooting mode and assist window (→p.36) can be used together.

## [] TOP 33[5M]

**Available Shooting modes:** All (except for , and )

Shooting continues up to 33 frames as long as the shutter button is held down. Use this setting for high speed continuous shooting.

### MEMO

[] QUALITY (→p.77) is limited to **5M**. The [] QUALITY setting changes and is displayed in yellow. When Shooting mode is set to other than [] TOP 33[5M], the restriction is cleared.

## [] TOP 33[3M]

**Available Shooting modes:** All (except for , and )

Shooting continues up to 33 frames as long as the shutter button is held down. Use this setting when your priority is continuous shooting speed over image quality, during continuous shooting.

### MEMO

- Whitish lines may appear around a bright spot in an image when using [] TOP 33[3M]. In this case, use [] TOP 33[5M].
- [] QUALITY (→p.77) is limited to **3M**. The [] QUALITY setting changes and is displayed in yellow in the LCD monitor. When Shooting mode is set to other than [] TOP 33[3M], the restriction is cleared.

### CAUTION [] TOP 33[3M]

[] EVF/LCD MODE in the [] SET-UP menu is automatically set to [30fps] (→p.156).

## Instant Zoom

Instant Zoom allows you to decide how to frame a picture while seeing the area around your subject on the screen. Instant Zoom is also quicker to zoom than optical zoom.

**Available Shooting modes:** All (except for  and )

Press  () to activate the Instant Zoom.

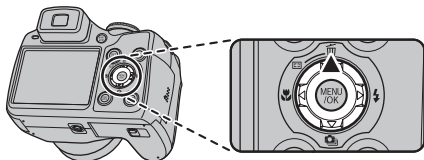

### MEMO

The color of the box can be changed (→p.111, 113).

### CHECK

 Intelligent Face Detection can detect faces within the box.

### CAUTION

Using the Instant Zoom allows you to enlarge your subject and shoot it. However, it will lower your image quality. Set the Instant Zoom when necessary.

## When optical zoom is used

- 1 Each time you press  () , the area to be enlarged changes.

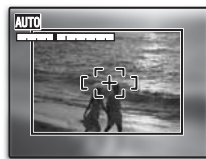



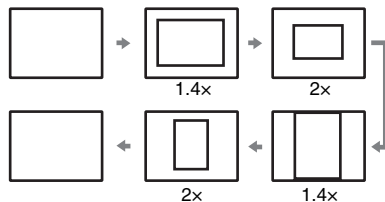

A box appears indicating the area to be enlarged.

The area to be enlarged changes like this.



- 2 Press the shutter button to record the image within the box.

### CAUTION

- When [ TOP 3] or [ LONG PERIOD] is set, only horizontal shots can be taken.
- When [ TOP 33 3M] or [ TOP 33 6M] is set, horizontal shots can be taken continuously up to 33 frames, and vertical shots can be taken continuously up to 26 frames.

**Continued** ➔

### When digital zoom is used

① Set [DIGITAL ZOOM] to [ON] (→p.111, 112).

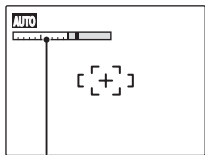

Zoom bar

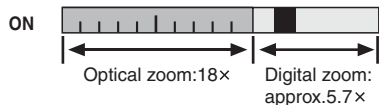

② Press (▲) while [DIGITAL ZOOM] is working.

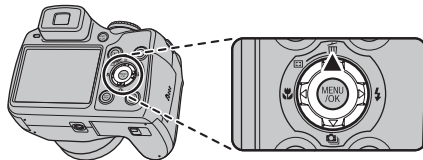

The screen switches to maximum optical zoom scale. The box appears indicating the area that will be enlarged with digital zoom.

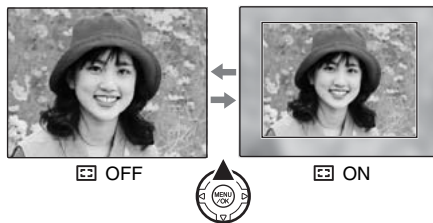

- ③ The size of the box changes as you change the digital zoom scale with the zoom lever.
- ④ Press the shutter button to record the image within the box.



# Using [*F*-MODE MENU] (Photography)/[SHOOTING MENU]

Use these menus to adjust image quality or focus. You can take pictures in a wide range of conditions.

## Setting the [*F*-MODE MENU] (Photography)

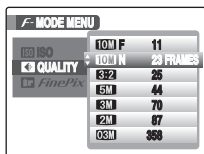

① Press **F** button to open the [*F*-MODE MENU].



② Press **▲** or **▼** to select the menu.



③ Press **▶**.



④ Press **▲** or **▼** to change the setting.



⑤ Press MENU/OK to confirm the setting.

## Setting the [SHOOTING MENU]

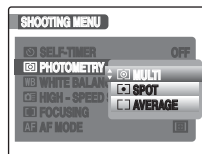

① Press MENU/OK to open the [SHOOTING MENU].



② Press **▲** or **▼** to select the menu.



③ Press **▶**.





④ Press **▲** or **▼** to change the setting.





























⑤ Press MENU/OK to confirm the setting.

**Continued** ➔

### ■ List of [F-MODE MENU] options

Menu	Functions	Settings	Factory default
[ISO] ISO (→p.76)	Specifies required sensitivity setting of the ambient light around the subject. The larger value of the sensitivity, the higher sensitivity is obtained. The higher sensitivity settings will allow you to take pictures in darker locations.	[AUTO]/[AUTO (1600)]/[AUTO (800)]/[AUTO (400)]/[6400]/[3200]/[1600]/[1800]/[400]/[200]/[100]/[64]	[AUTO (800)]
[QUALITY] (→p.77)	Specifies the image size. The larger image size, the better image quality is obtained. The smaller image size, the larger number of images are recorded.	<b>10M</b> F/10M N/8:2/ 5M/3M/2M/3M	<b>10M</b> N
[FinePix COLOR] (→p.78)	Specifies required color tone. This mode is effective for taking more vivid shots or black and white shots.	[STD]/  / 	[STD]

### ■ List of [SHOOTING MENU] options

Menu	Functions	Settings	Factory default
[SCENE POSITION] (→p.52)	This setting can be used when the Mode dial is set to SP. Use this setting to provide the best Shooting menu setting for the scene being shot.	 /  /  /  /   /  /  /  /   / 	
[SELF-TIMER] (→p.79)	This setting can be used in all shooting modes.	 /  /OFF	OFF
[PHOTOMETRY] (→p.80)	This setting can be used when the Mode dial is set to M, A, S or P. Use this setting to specify the light metering method.	 /  /[ ]	
[WB WHITE BALANCE] (→p.81)	This setting can be used when the Mode dial is set to M, A, S, P or  . Use this setting to adjust the color balance to suit the color of the ambient light around the subject.	[AUTO]/  /  /   /  /  / 	[AUTO]

Menu	Functions	Settings	Factory default
[] HIGH-SPEED SHOOTING (→p.83)	This setting cannot be selected in . When setting [ SPORT] mode, the camera sets to [ HIGH-SPEED SHOOTING] mode automatically. Use this setting to reduce the time required for focusing.	[ON]/[OFF]	[OFF]
[] FOCUSING (→p.83)	This setting can be used when the Mode dial is set to M, A, S or P. Use this setting to specify the focusing mode.	/  /	
[] AF MODE (→p.85)	This setting can be used when the Mode dial is set to M, A, S or P. Use this setting to specify the focusing area.	/  /	
[] SHARPNESS (→p.87)	This setting can be used when the Mode dial is set to M, A, S or P. Use this setting to soften or emphasize the outline of an image.	[HARD]/ [STANDARD]/ [SOFT]	[STANDARD]
[] FLASH (→p.87)	This setting can be used when the Mode dial is set to M, A, S or P. Use this setting to adjust the amount of light emitted by the flash to suit the photography conditions or to achieve a desired effect.	-2/3 EV to +2/3 EV in approx. 1/3 EV increments	0
[] BRACKETING (→p.88)	This setting can be used when the Mode dial is set to M, A, S or P. Use this setting to photograph the same image with different exposure settings.	±1/3 EV, ±2/3 EV, ±1 EV	±1/3 EV

## Changing the sensitivity setting ([ISO ISO])

Use this menu to specify required sensitivity setting of the ambient light around the subject.

The larger value of the sensitivity, the higher sensitivity is obtained. The higher sensitivity settings will allow you to take pictures in darker locations.

### CHECK

#### Settings

[AUTO]/[AUTO(1600)]/[AUTO(800)]/[AUTO(400)]/[6400]/[3200]/[1600]/[800]/[400]/[200]/[100]/[64]  
Selecting [AUTO]/[AUTO(1600)]/[AUTO(800)]/[AUTO(400)] as the sensitivity setting, the camera selects the best sensitivity setting for the subject's brightness.

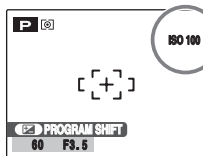

The selected sensitivity setting appears on the screen when the sensitivity setting is set to the setting other than [AUTO].

- About [AUTO(1600)]/[AUTO(800)]/[AUTO(400)]**  
 [AUTO(1600)]/[AUTO(800)]/[AUTO(400)] can be selected when the Mode dial is set to P. For [AUTO(1600)]/[AUTO(800)]/[AUTO(400)], sensitivity is automatically set in the same way as for [AUTO], but the highest sensitivity is limited. Select [AUTO(1600)]/[AUTO(800)]/[AUTO(400)] depending on the scene.

### MEMO

- When anything other than M, A, S and P in the Shooting mode is selected, only AUTO can be selected for the ISO (sensitivity) setting.
- When M, A, S and P in the Shooting mode is selected, AUTO cannot be selected for the ISO (sensitivity) setting.
- [QUALITY] is limited to **SM**, when [ISO ISO] is set to 6400 or 3200. [QUALITY] automatically changes and is displayed in yellow in the LCD screen. When [ISO ISO] is set to other than 6400 or 3200, the restriction is cleared.

### CAUTION

- Although higher sensitivity settings will allow you to take pictures in darker locations, they will also increase the amount of speckling in your images. Choose the sensitivity setting that best suits the conditions.
- When 3200 or 6400 is set for [ISO ISO], image resolution will be lower than if shot at a sensitivity setting lower than 1600.

## Changing the quality setting ([**QUALITY**])

Use this menu to specify the image size (number of recorded pixels).

Select the quality setting for the scene being shot.

### Quality settings in Shooting mode

Quality mode	Sample uses
<b>10M</b> F (3648 × 2736)	Printing at up to 10R (25.4 × 30.5 cm/ 10 × 12 in.) / A3 size
<b>10M</b> N (3648 × 2736)	
<b>3:2</b> (3648 × 2432)	
<b>5M</b> (2592 × 1944)	Printing at up to 10R (25.4 × 30.5 cm/ 10 × 12 in.) / A4 size
<b>3M</b> (2048 × 1536)	Printing at up to 6R (15.2 × 20.3 cm/ 6 × 8 in.) / A5 size
<b>2M</b> (1600 × 1200)	Printing at up to 4R (10.2 × 15.2 cm/ 4 × 6 in.) / A6 size
<b>10M</b> (640 × 480)	To use for e-mail or web site

### Area shot and quality setting

Area shot excluding **3:2**



Area shot with **3:2**



Normal shooting provides an aspect ratio of 4:3 and **3:2** shooting provides an aspect ratio of 3:2 (same aspect ratio as 35 mm film and post card).

### MEMO



- The bigger the number of recorded pixels, the better the image quality becomes. As the number of recorded pixels becomes smaller, you will be able to record more frames to a Memory Card.
- The quality setting is retained even when the camera is turned off or the mode setting is changed.
- When changing the quality setting, the number of available frames also changes (→p.154). The numbers to the right of setting show the number of available frames.
- The quality setting is fixed to **10M** when Shooting mode is set to **☺** (→p.54).
- [**ISO** ISO] is limited to 1600 when [**QUALITY**] is set to **10M** or **3:2**. The [**ISO** ISO] setting automatically changes and is displayed in yellow in the LCD screen. When [**QUALITY**] is set to other than **10M** or **3:2**, the restriction is cleared.

## Changing the FinePix COLOR setting ([ FinePix COLOR])

Use this menu to specify required color tone.  
It is effective for taking vivid shots or black and white shots.

### CHECK

#### FinePix COLOR settings

[STD] [F-STANDARD]	The contrast and color saturation are set to standard. Use this mode for normal photography.
 [F-CHROME]	The contrast and color saturation are set to high. This mode is effective for taking more vivid shots of subjects such as flowers.
 [F-B&W]	This mode converts the colors in the photographed image to black and white.

When setting [F-CHROME] or [F-B&W], the icon appears on the screen.

### CAUTION

When the Mode dial is set to SP,  does not appear on the screen.

### MEMO



- The FinePix COLOR setting is retained even when the camera is off or the mode setting is changed.
- F-CHROME may have little visible effect with some subjects or the scene being shot. You may not be able to see any difference on the screen.

## Setting self-timer ([ SELF-TIMER])

Available Shooting modes: All

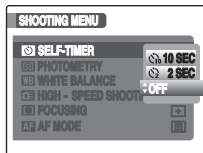
The self-timer is used in situations where the photographer is included in the shot.



- : The picture is taken after 10 seconds.
- : The picture is taken after 2 seconds.

### Taking pictures using self-timer

- ① Press the shutter button down halfway to focus on the subject and press the shutter button fully.

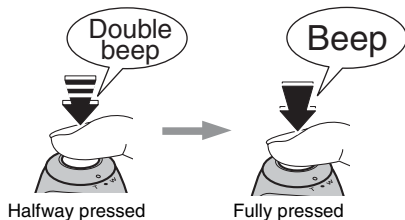

Pressing the shutter button down halfway that focuses on the subject.

Without releasing the shutter button, press the button all the way down (fully pressed) to start the self-timer.

- ② Take pictures in selected time.

A picture is taken after the self-timer lamp changes from lit to blinking (only blinks with the 2-second self-timer).

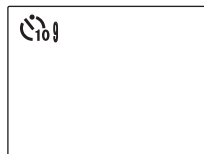
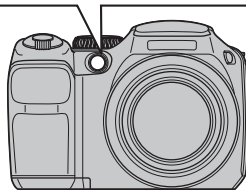
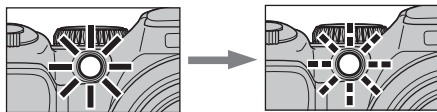

A countdown appears on the LCD monitor indicating the time remaining until the picture is taken.

**Continued** ➔

**Using the 2-second self-timer**

This is useful when you worry about camera shake even if attaching the camera on a tripod.

**MEMO**

- To stop the self-timer, once it has started running, press DISP/BACK.
- Any of the following cancels the self-timer setting:
  - Completing the shooting
  - Changing the Shooting mode setting
  - Setting the camera to Playback mode
  - Turning the camera off
- Take care not to stand in front of the lens when pressing the shutter button as this can prevent the correct focus or brightness (exposure) from being achieved.

**Taking pictures with the self-timer and Intelligent Face Detection function**

Available Shooting modes: **AUTO**, , **N**, , , **zoom**, **SP** (, , , , , OFF, ) , M, A, S, P

** Intelligent Face Detection**

The Intelligent Face Detection function is especially useful when using the self timer since it ensures that faces will appear in focus automatically.

**Selecting light metering method  
([ PHOTOMETRY])**

**Available Shooting modes:** M, A, S, P  
(When Intelligent Face Detection is turned OFF)

Use this setting when the correct exposure cannot be obtained by the shooting conditions.

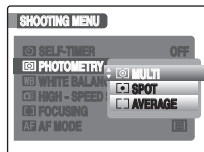

[ MULTI] (Pattern): Light metering where the camera assesses the scene and selects the correct exposure.

[ SPOT] : Light metering where the exposure is optimized for the center of the image.

[ AVERAGE] : Light metering where an average value for the entire image is used.



**To use the photometry modes effectively**• **[MULTI]**

In this mode, the camera uses automatic scene recognition to analyze the subject and provide optimum exposure in a wide range of shooting conditions.

• **[SPOT]**

This mode is useful for subjects with strongly contrasting light and dark areas where you want to achieve the correct exposure for a particular feature.

• **[AVERAGE]**

The advantage of this mode is that the exposure tends not to change for different compositions or subjects. This mode is particularly effective for shots of people wearing black or white clothing and shots of scenery.



## Adjusting color balance ([WB] WHITE BALANCE)

**Available Shooting modes:** M, A, S, P,

Adjust the color balance based on white to suit the color of the ambient light around the subject.

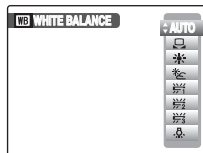

[AUTO]: Automatic adjustment



: Select the white balance by using white paper to suit the shooting conditions.



: Shooting outdoors in good weather



: Shooting in shade



: Shooting under Daylight fluorescent lamps



: Shooting under Warm White fluorescent lamps



: Shooting under Cool White fluorescent lamps



: Shooting in incandescent light

**Continued** ➔

## Custom white balance

- 1 Select  custom white balance (→p.73).
- 2 Hold a piece of white paper under the light source for setting the white balance, so that it fills entire the screen. Then press the shutter button to set the white balance.

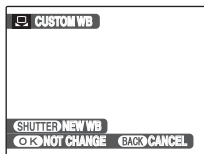

### MEMO

To use the white balance set previously, press the MENU/OK without pressing the shutter button.

- 3 When the correct exposure is measured, [COMPLETED!] appears. Press MENU/OK to confirm the setting.

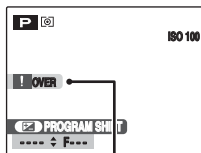
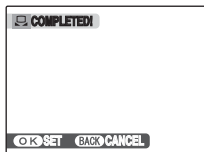

### OVER or UNDER

Set the exposure compensation again, using a negative value (–) when [OVER] appears and a positive value (+) when [UNDER] appears (→p.63).

### Example

You can change the white balance for a photographed image by using colored paper instead of white paper.

### MEMO

- In AUTO mode, the correct white balance may not be achieved for subjects such as close-ups of people's faces and pictures taken under a special light source. Select the correct white balance for the light source.
- When the flash fires, the white balance (except for custom white balance) setting for the flash is used. Consequently, to achieve a particular effect, the flash mode should be set to Suppressed flash (→p.67).
- The specified custom white balance is retained until it is reset. This setting is retained even if the batteries are removed.
- The color tones may vary depending on the shooting conditions (light source, etc.).
- After taking the picture, check the image color (white balance).
- Explanation of Terms "White Balance" (→p.157)
- When [  AUCTION MODE] is selected, custom white balance cannot be set.



## ⬡ Focusing the shot quickly ([ HIGH-SPEED SHOOTING])

Available Shooting modes: All (except for )

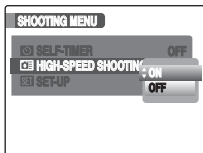
Use this mode to reduce the time required for focusing when pressing the shutter button down halfway. It is useful to avoid missing snapshot opportunities.



### ⚠ CAUTION

[ EVF/LCD MODE] in the [ SET-UP] menu is automatically set to 60fps (→p.156).

### 📄 MEMO

- When taking pictures while the [HIGH-SPEED SHOOTING] mode is set to [ON], the batteries will run down more quickly.
- When setting  Sport mode, the camera sets to [HIGH-SPEED SHOOTING] mode automatically.

## ⬡ Specifying the focusing mode ([ FOCUSING])

Available Shooting modes: M, A, S, P  
(Intelligent Face Detection automatically turns off.)

Use this mode to specify focusing mode that best suits the subject.

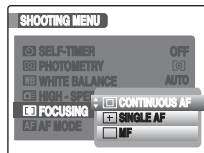

- : [CONTINUOUS AF]
- : [SINGLE AF]
- : [MF]

**Continued** ➔

## [CONTINUOUS AF]

Use this setting to take pictures of a moving subject. The camera continues to focus on the main subject in the AF frame.

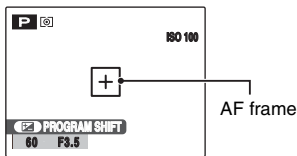

### ! CAUTION

- When using [CONTINUOUS AF], attention must be given to the battery level. The battery level (power consumption) increases when using [CONTINUOUS AF]. Because the camera focuses continuously without pressing the shutter button.
- When using [CONTINUOUS AF], [AF MODE] is set to [CENTER] automatically.

## [+ SINGLE AF]

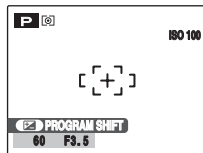

Use this setting to take picture of a static subject such as a landscape.

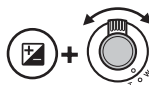
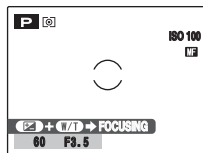

## [MF]

This mode is used in situations where you focus manually. Use this setting for alternative focusing or for intentionally out-of-focus shots.



- While pressing , turn the zoom lever towards W or T to focus. The  mark changes to yellow when the subject is in focus.



- Press the shutter button to take pictures.

## Specifying the focusing area ([AF] AF MODE)

**Available Shooting mode:** M, A, S, P  
(When Intelligent Face Detection is turned OFF)

Use this mode to specify the focusing area that best suits the subject.

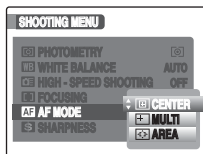

- [C] : [CENTER]
- [+ ] : [MULTI]
- [A] : [AREA]

### [C] CENTER

The camera focuses on the center of the screen.  
Use this setting when taking pictures with AF/AE lock  
(→p.32).

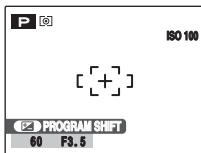

### [+ ] MULTI

When pressing the shutter button down halfway, the camera recognizes any strongly contrasting subject near the center of the screen and displays the AF frame over subject in focus.



Halfway pressed



AF frame

### ! CAUTION

When taking pictures in Macro mode, the camera focuses on the center of the screen.

### MEMO

When the AF frame does not appear in the focusing position, select [C] CENTER in the AF mode and use AF/AE lock (→p.32).

**Continued** →

[ AREA]

The camera changes the focusing position on the screen. Use this setting when composing the shot using a tripod and changing the focusing position.

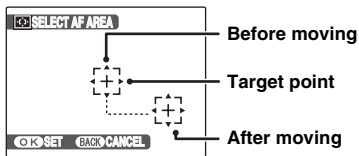

- ① Press ▲, ▼, ◀ or ▶ to move the  (target point) to the focusing position.

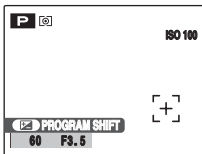

- ② The AF frame appears in the location to which the target point was moved when you press MENU/OK.



- ③ Press the shutter button to take pictures.

**MEMO**

- To reposition the AF frame, repeat step ①.
- Regardless of the AF frame location, the exposure is always set using the area in the center of the screen. To expose the shot for your main subject, use AF/AE lock (→p.33).

## Adjust the image outline (hard/soft) ([**S**] SHARPNESS)

Available Shooting modes: M, A, S, P

Use this setting to soften or emphasize the outline and quality of an image.

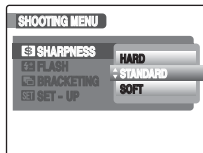

### [HARD]:

Emphasizes the outlines. Best for shots of subjects such as buildings or text where sharp images are desirable.

### [STANDARD]:

Best for ordinary photography. Provides edge sharpness that is ideal for most picture taking situations.

### [SOFT]:

Softens the outlines. Best for shots of subjects such as people, where a softer image is desirable.

## Adjust the amount of light emitted by the flash ([**L**] FLASH) (Brightness Adjustment)

Available Shooting modes: M, A, S, P

Use this setting to change the amount of light emitted by the flash to suit the photography conditions or to achieve a desired effect.

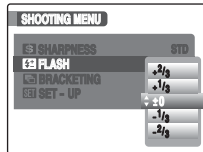

### ! CAUTION

- Depending on the type of subject and the shooting distance, brightness adjustment may have no effect.
- The image may appear dark when setting the shutter speed to higher than 1/1000 sec.

## Photograph the same image with different exposure ([ BRACKETING])

Available Shooting modes: M, A, S, P

Use this setting to photograph the same image with different exposure settings. Bracketing shoots 3 continuous frames, one of which is correctly exposed while the remaining two are underexposed and overexposed respectively by a set amount.

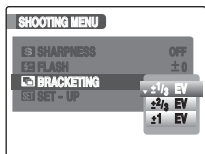



### ! CAUTION

- If the underexposed or overexposed frame is outside the camera's control range, the picture is not taken with the specified setting increments.
- Flash photography cannot be used.
- This feature always takes 3 shots. However, if there is insufficient space on the Memory Card or internal memory for 3 shots, no picture will be taken.

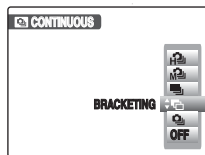

### MEMO [BRACKETING]



After setting the exposure for bracketing, select [ BRACKETING] by pressing .



# Playback Information

Shooting information can be checked when the camera is set to single-frame playback mode. Press  to check the information. Press  again to return to playback mode.

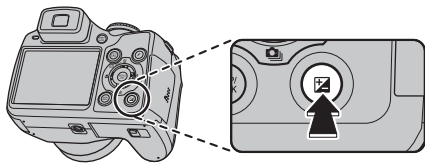

- 1 Quality mode
- 2 Sensitivity
- 3 Shutter speed/Aperture
- 4 FinePix COLOR
- 5 Flash
- 6 White balance
- 7 Exposure compensation setting
- 8 Frame number
- 9 Histogram

## ! CAUTION

- Highlight warning



Overexposed area blinks in black.

Highlight warning

## Histograms

A histogram is a chart showing the distribution of brightness in an image (horizontal axis: brightness; vertical axis: pixels).

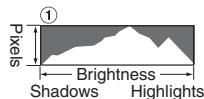

- 1 Optimal exposure:  
There is an ample distribution of pixels overall with a peak in the middle range.



- 2 Overexposed:  
The number of highlight pixels is high with the distribution sloping upwards to the right.



- 3 Underexposed:  
The number of shadow pixels is high with the distribution sloping upwards to the left.

## ! CAUTION

The shape of the graph will vary depending on the subject.

# Using [*F*-MODE MENU] (Playback)/[PLAYBACK MENU]

Use these menus to playback photographed images.

## Setting the [*F*-MODE MENU] (Playback)

- ① Set the camera to Playback mode (→p.37).

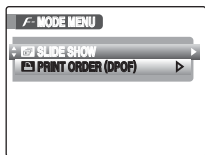

- ② Press **F** button to open the [*F*-MODE MENU].



- ③ Press **▲** or **▼** to select the menu.



- ④ Press **▶**.



- ⑤ Press **▲** or **▼** to change the setting.



- ⑥ Press MENU/OK to confirm the setting.

## Setting the [PLAYBACK MENU]

- ① Set the camera to Playback mode (→p.37).

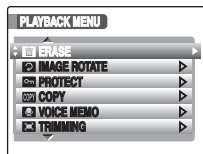

- ② Press MENU/OK to open the [PLAYBACK MENU].



- ③ Press **▲** or **▼** to select the menu.



- ④ Press **▶**.



- ⑤ Press **▲** or **▼** to change the setting.



- ⑥ Press MENU/OK to confirm the setting.

## Setting automatic playback ([SLIDE SHOW])

Use this mode to playback photographed images continuously. You can select type of image transition.

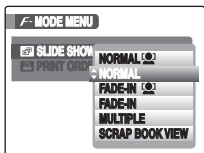

### MEMO

- To interrupt automatic playback, press MENU/OK.
- Press ◀ or ▶ to advance or go back through the images when selecting [NORMAL] and [FADE-IN].
- The Auto power off function (→p.118) does not operate during playback.
- Movie starts automatically. When the movie ends, the playback function moves it on.
- Press DISP/BACK once during playback to display on-screen help.
- The date is displayed on the Slide Show (except [MULTIPLE]) if the date is displayed on the Single-Frame Playback.
- The camera plays back the image taken with Intelligent Face Detection (→p.29) zoomed in on the detected face when [NORMAL ] or [FADE-IN ] is selected.

## DPOF set frame ([PRINT ORDER (DPOF)])

You can specify the image, number of prints, with or without date of printing with a DPOF-compatible printer.

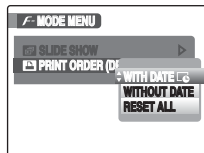

[WITH DATE ] : The date will be imprinted on your prints.

[WITHOUT DATE]: The date will not be imprinted on your prints.

[RESET ALL] : All DPOF settings will be canceled.

**Continued** ➔

**[WITH DATE] / [WITHOUT DATE]**

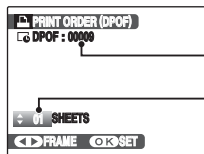

Selecting [WITH DATE] ,  appears on the screen and the date will be imprinted on your prints.





Total number of prints

Setting for that frame



- 1 Press  or  to display the frame (file) for specifying DPOF setting.



- 2 Press  or  to set a value.  
Up to 99 sheets are printed.  
For frames (files) that you do not want printed, set the number of prints to 0 (zero).

To specify more DPOF settings, repeat steps ① and ②.











- 3 Always press MENU/OK after the settings are completed.  
Pressing DISP/BACK cancels those settings.



- 4 Press MENU/OK again. The total number of prints appears on the screen.

 **MEMO Canceling DPOF setting**

- 1 Press **F** to open the [F-MODE MENU] and press  or  to select [PRINT ORDER (DPOF)].
- 2 Press .
- 3 Press  or  to select [WITH DATE]  or [WITHOUT DATE] and press MENU/OK to display the print order screen.
- 4 Press  or  to select the frame (file) with the DPOF setting you want to cancel.
- 5 Press  to set the number of prints to 0 (zero).

To cancel the DPOF setting for another frame (file), repeat steps ④ and ⑤.

Always press MENU/OK to complete the settings.

- [RESET ALL] (→p.94)

 **MEMO**

- When DPOF settings were specified on another camera.

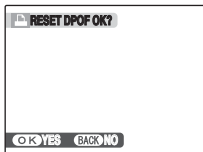

When the data includes a frame (file) with DPOF settings that were specified on another camera, [RESET DPOF OK?] appears.





Pressing MENU/OK erases all of the DPOF settings already specified for each frame (file). Specify the DPOF setting for each frame (file) again.

- Prints of up to 999 frames (files) can be ordered on the same Memory Card.
- DPOF settings cannot be specified for movies.

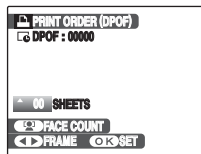
 **CAUTION**

- Pressing DISP/BACK while choosing settings will cancel all current settings. If there were previous DPOF settings, only the modifications are canceled.
- When selecting the [WITH DATE ] setting, the date is imprinted on your shots using the Print Service or a DPOF-compatible printer (depending on the printer specifications, the date may not be printed in some cases).
- Images photographed with a camera other than FinePix S8100fd may not be specified DPOF settings.

 **Intelligent Face Detection**

When DPOF settings are set to the images taking with the Intelligent Face Detection (→p.29) ( appears on the screen), press  (Intelligent Face Detection), the frame appears around the detected face, and then the number of the detected faces is set to print number. It is easy to set the number of prints for each person in the picture. Press  or  to set the print number. Press  (Intelligent Face Detection) again, the number of the detected faces is set to the print number. After setting, press MENU/OK.

**Continued** 

**[RESET ALL]**

To cancel all DPOF settings:

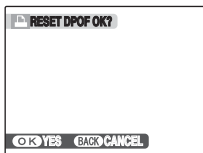

Select [RESET ALL] in the [F-MODE MENU] (→p.91).

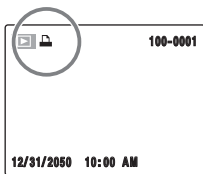

Press MENU/OK.

 **MEMO**

 appears on the screen during playback when the image has specified DPOF settings.

**[  PRINT ORDER (DPOF)]**

DPOF stands for Digital Print Order Format and refers to a format that is used for recording printing specifications for images shot using a digital camera on media such as a Memory Card. The recorded specifications include information on which frames are to be printed.

\*Some printers do not support date and time imprinting or specification of the number of prints.

\*The warnings shown below may appear while specifying the prints.

[DPOF SPECIFIED. ERASE OK ?]

[DPOF SPECIFIED. ERASE ALL OK ?] (→p.44)

When erasing the image, the DPOF setting for that image is deleted at the same time.

[RESET DPOF OK ?] (→p.93)

When inserting a Memory Card that contains images specified for printing by another camera, those print specifications are all reset and replaced by the new print specifications.

[DPOF FILE ERROR] (→p.143)

Up to 999 images can be specified on the same Memory Card.

## Rotating the images ([IMAGE ROTATE])

When shooting in the vertical position, the image appears horizontal on the screen. Use this mode to rotate an image and to display correct direction. Your camera calls images “frames”.

### CAUTION

Protected frames (files) cannot be rotated. Unprotect the frames (files) before rotating them (→p.97).

### MEMO

An image can be rotated only when playing back using FinePix S8100fd. You may not be able to rotate images that were shot with a camera other than the FinePix S8100fd.

- ① Press ◀ or ▶ to select the rotating frame (file).
- ② Press MENU/OK to open the [PLAYBACK MENU].
- ③ Press ▲ or ▼ to select [IMAGE ROTATE].
- ④ Press ▶.

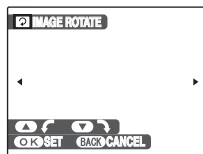

- ⑤ Press ▲ or ▼ to rotate the image.  
▼: Rotates the image clockwise at a 90 degree angle.  
▲: Rotates the image counterclockwise at a 90 degree angle.



- ⑥ Press MENU/OK to confirm the setting. Next time the image is played back, it will be automatically rotated. Press DISP/BACK to cancel rotating the image.



## Protecting the images ([ PROTECT])

Use this mode to prevent frames (files) from being accidentally erased. Your camera calls images “frames”.

### [FRAME]

To protect or unprotect only the selected frame (file):

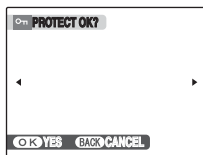

Unprotected

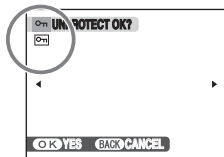

Protected ( appears)



- ① Press ◀ or ▶ to select the protecting/unprotecting frame (file).



- ② Press MENU/OK to protect/unprotect the currently displayed frame (file).  
Unprotected: protecting frame (file)  
Protected: reset frame (file)

To protect another frame (file), repeat steps ① and ②.  
When protecting frames (files) is completed, press DISP/  
BACK.

### [SET ALL]

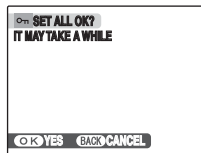

Press MENU/OK to protect all the frames (files).

### [RESET ALL]

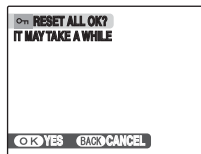

Press MENU/OK to unprotect all the frames (files).

**Continued** ➔

 **MEMO** To stop the procedure midway

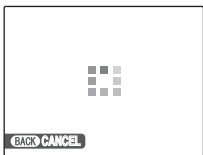

If the images are very large, protecting or unprotecting all the frames (files) may take some time.  
If you want to take a picture or record a movie during the procedure, press DISP/BACK.

 **CAUTION**

The Format function erases all the frames (files), including protected frames (files) (→p.117).

 **Copying the images**  
**([COPY] COPY)**

It is possible to transfer saved images between the internal memory and a Memory Card. Your camera calls images "frames".

■ **Selecting COPY**

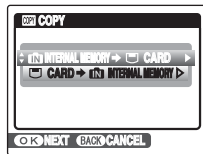

- ① Press ▲ or ▼ to select [ INTERNAL MEMORY →  CARD] or [ CARD →  INTERNAL MEMORY].



- ② Press ►.

**Copying the images to another Memory Card**

Copy images from the Memory Card inserted in your camera to the internal memory using the Copy Image function, then remove that Memory Card and insert another Memory Card into the camera. Then, copy the images to the Memory Card from the internal memory.

## Copying one frame at a time ([FRAME])

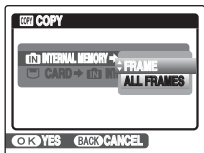

- ① Press ▲ or ▼ to select [FRAME].



- ② Press MENU/OK.



- ③ Press ◀ or ▶ to select the copying frame (file).



- ④ Press MENU/OK to copy the currently displayed frame (file).

### MEMO

To copy another frame (file), repeat steps ③ and ④. When copying frames (files) is completed, press DISP/BACK.

## Copying all frames ([ALL FRAMES])

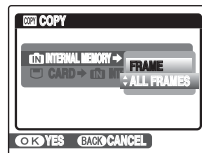

- ① Press ▲ or ▼ to select [ALL FRAMES].



- ② Press MENU/OK.



- ③ Press MENU/OK to copy all the frames (files).





### ! CAUTION

- When [MEMORY FULL] or [MEMORY FULL] appears on the screen, copying the data stops on the way.
- When copying the image that has specified DPOF setting, the DPOF setting is not copied.

## Adding voice memos to the images ([ VOICE MEMO])

Voice memos of up to 30 seconds can be added to still images.

### Recording voice memos

- 
 ① Press ◀ or ▶ to select the image to add a voice memo.
- 
 ② Press MENU/OK to open the [PLAYBACK MENU].
- 
 ③ Press ▲ or ▼ to select [ VOICE MEMO].
- 
 ④ Press ▶.



- Press MENU/OK to start recording.

The remaining recording time appears during recording.

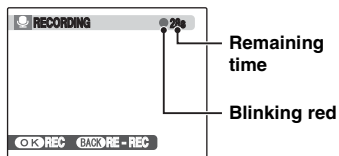

### MEMO

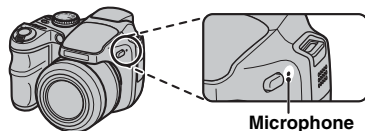

**Microphone**

Face the microphone to record your comment.  
Hold the camera about 20 cm (7.9 in.) away for the best results.

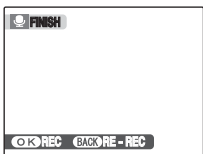

- ⑥ The voice memo ends when pressing MENU/OK midway or 30 seconds pass.

To record your comment: press MENU/OK.  
To rerecord the comment: press DISP/BACK.

#### MEMO

- When the image already has a voice memo



If you select an image that already has a voice memo, a screen appears in which you can select whether to rerecord the memo.

- When [PROTECTED FRAME] appears, unprotect the frame (→p.97).
- Voice memos cannot be added to movies.

### Playing back voice memo



- ① Press ◀ or ▶ to select an image file with a voice memo.  appears on the screen.



- ② Press ▼ to start playing back the voice memo.

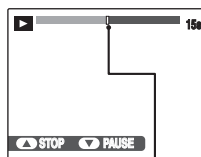

Progress bar

The playback time appears on the screen along with a progress bar.

#### CAUTION

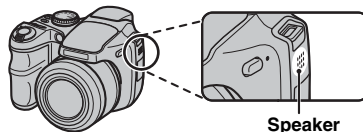





Speaker

Uncover the speaker.  
The sound may be difficult to hear.

**Continued** →

## ■ Playing back voice memos

	Control	Description
Playback		Playback begins. The voice memo stops when playback ends.
Pause / Resume		Pauses the voice memo during playback. Press ▼ again to resume playback.
Stop		Stops playback. Press ◀ or ▶ while voice memo playback is stopped to go back to the previous file or advance to the next file respectively.
Fast forward / Rewind		Press ◀ or ▶ during playback to skip forwards or backwards through the voice memo. These buttons do not function while playback is paused.

### ✓ CHECK

- Audio recording format:  
WAVE (→p.156), PCM recording format
- Audio file size:  
Approx. 480 KB (for a 30-second voice memo)

### 📄 MEMO Playing voice memo files

You may not be able to play back some voice memo files recorded on other cameras.

## Adjusting volume of voice memos

Volume can be adjusted while playing back voice memos.

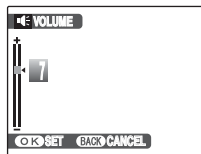

- 1 Press MENU/OK while playing back voice memo.  
The voice memo is paused during playback.



- 2 Press ▲ or ▼ to adjust the volume.



- 3 Press MENU/OK to confirm your selection.  
Camera starts to play back the voice memo.

## Trimming the images ([TRIMMING])

Use this mode to trim the required part of the photographed image.

### ✓ CHECK

Before selecting [TRIMMING], select the trimming frame (file).

W:wide zoom lever  
(Zoom out)

T:tele zoom lever  
(Zoom in)

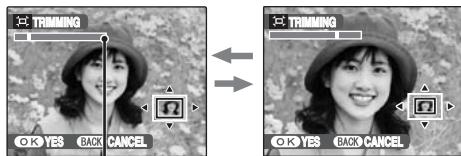

Zoom bar



- 1 Turn to W or T to zoom in or out on an image.

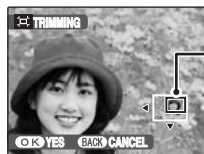

Navigation screen  
(Current displayed image)



- 2 Press ▲, ▼, ◀ or ▶ to move to another part of the image.



- 3 Press MENU/OK.

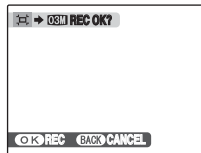

- 4 Check the saved image size and press MENU/OK.  
The trimmed image is added as a separate file in the final frame.

**Continued** ➔

## MEMO

- Pressing DISP/BACK in step ① or ② returns to single-frame playback.
- A saved image size varies depending on the zoom scale of step ①. For 0.3 M, **OK** YES option appears in yellow.
- Image sizes

5M	Printing at up to 10R (25.4 × 30.5 cm / 10 × 12 in.) / A4 size
3M	Printing at up to 6R (15.2 × 20.3 cm / 6 × 8 in.) / A5 size
2M	Printing at up to 4R (10.2 × 15.2 cm / 4 × 6 in.) / A6 size
0.3M	To use for e-mail or web site



- When **3:2** quality setting is selected, the image is trimmed to normal size (4:3 aspect ratio).

## CAUTION

You may not be able to trim images that were shot with a camera other than FinePix S8100fd.

## Intelligent Face Detection



Images taken with the Intelligent Face Detection (→p.29) (  appears on the screen). Press  (Intelligent Face Detection), the face that is focused on is zoomed in to help crop the main subject. To specify a cropped part of the image according to preference, specify and adjust according to the procedure in [TRIMMING].



# Recording Movies

Use this mode to record movies with sound.

## 1 Set the camera to MOVIE mode.

Set the Mode dial to .

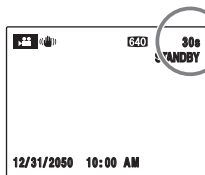
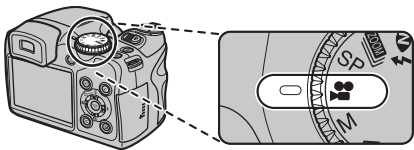

The available recording time appears on the screen.

## MEMO

While in standby, pressing the  Dual IS button enables you to take stable and blur-free images even under difficult shooting conditions, such as telephoto shooting.

## ■ Zooming the image

You must zoom beforehand as you cannot zoom during recording.

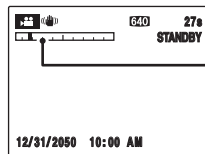

Zoom bar



Turn the zoom lever to zoom in or out on an image.

**Continued** ➔

## 2 Record movies.



Fully pressed

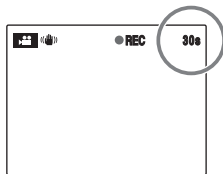

Press the shutter button down fully to start recording. During recording, [●REC] and a counter that shows the remaining time appear on the screen.



Halfway pressed

Recording ends when pressing the shutter button down halfway during recording or the remaining time runs out.

### MEMO

There is no need to hold down the shutter button during recording.

### CHECK Recording movies

- Specifications: Motion JPEG (→p.156), Monaural sound
- Quality selection method: **640** (640 × 480 pixels)  
**320** (320 × 240 pixels)
- Frame rate (→p.156): 30 frames per second (fixed)

### MEMO

- The brightness and color of the screen shown during movie recording may differ from those shown before recording begins.
- The exposure and white balance will be automatically adjusted to the scene being shot even after recording has started.
- If recording is stopped immediately after it begins, 1 second of the movie is recorded onto the Memory Card or internal memory.

### CAUTION

- Because a movie is recorded onto the Memory Card or internal memory as it is saved, it cannot be recorded correctly if the camera suddenly loses power (if the batteries run out or the AC power adapter is disconnected).
- A movie file taken by FinePix S8100fd may not be playable on other cameras.
- [EVF/LCD MODE] in the [SET-UP] menu is automatically set to [30 fps] (→p.156).
- Because sound is recorded concurrently with the images, make sure that you do not cover the microphone with a finger, etc. (→p.11).
- Camera operation noises may be recorded during movie shooting.
- The size of a movie file can be up to 2 GB.

## Changing movie size

Press **F** to open the [**F**-MODE MENU].

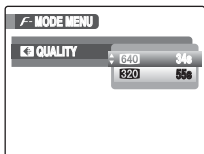

① Press **▶**.



② Press **▲** or **▼** to change the setting.



③ Press **MENU/OK** to confirm the setting.

### Quality settings in Movie mode

**640** (640 × 480 pixels): For better quality

**320** (320 × 240 pixels): To record longer movies

### MEMO

- The quality setting is retained even when the camera is turned off or the mode setting is changed.
- In **Movie** mode, you cannot set the [**ISO**] (sensitivity) setting and [**FinePix COLOR**] setting.
- See p.154 for information on recording times per Memory Card or internal memory.

### CAUTION

If you shoot using the **xD-Picture Cards** with model numbers containing "M" such as DPC-M1GB, movie recording time may be reduced if you repeatedly record and erase (frame erase) image files. In such a case, erase all frames or format the **xD-Picture Card** before use. Back up important frames (files) onto your PC or another media.

# ▶ Playing Back Movies

Setting the camera to ▶  
Playback mode (→p.37)

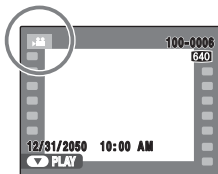

① Press ◀ or ▶ to select the movie file. ▶ appears on the screen.



② Press ▼ to begin playing back movie.

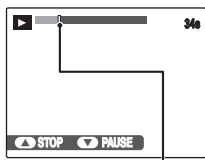

Progress bar

The playback time appears on the screen along with a progress bar.

## ■ Playing back movies

	Control	Description
Playback		Playback begins. Playback stops when the end of the movie is reached.
Pause / Resume		Pauses the movie during playback. Press ▼ again to resume playback.
Stop		Stops playback. Press ◀ or ▶ while playback is stopped to go back to the previous file or advance to the next file respectively.
Fast forward / Rewind		Press ◀ or ▶ during playback to skip forwards or backwards through the movie.
Skip playback		Press ◀ or ▶ when the movie is paused, the movie advances or goes back one frame. Hold down ◀ or ▶ to move through the frames quickly.

 **MEMO**

If the subject of the shot is very bright, white vertical streaks or black horizontal streaks may appear in the image during playback. This is normal.

 **CAUTION**

- You may not be able to playback some movie files recorded on other cameras.
- To playback movie files on a PC, save the movie file on the Memory Card or internal memory to the PC's hard disk and then playback the saved file.
- Uncover the speaker. The sound is difficult to hear.

**Adjusting volume of movies**

Volume can be adjusted while playing back movies.

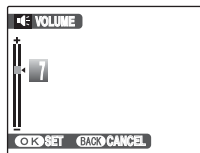

- 1 Press MENU/OK while playing back movie.  
The movie is paused during playback.



- 2 Press ▲ or ▼ to adjust the volume.



- 3 Press MENU/OK to confirm the setting.  
Camera starts to playback the movie.

## Setting Silent Mode

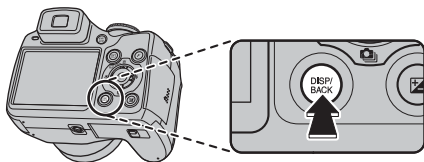

Set Silent mode by pressing and holding DISP/BACK. Use this mode for taking pictures in places where making an operation or shutter sound is restricted. Operation sound, shutter sound, voice memo playback sound, and the self-timer lamp are disabled.

### MEMO

- Press and hold DISP/BACK again to release Silent mode.
- Release Silent mode to adjust sound volume.
- When the use of flash is restricted, press the flash down to change the camera to Suppressed flash mode (→p.67).
- Silent mode cannot be set while playing back movies or voice memos.

## Using the [SET-UP] menu

### 1 Open the [SET-UP] menu.



① Press MENU/OK to open the menu.



② Press ▲ or ▼ to select [SET] SET-UP.



③ Press ►.

### 2 Change the page.

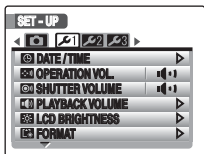

① Press ◀ or ▶ to select the page.



② Press ▼ to move to menu item.

### 3 Change the setting.

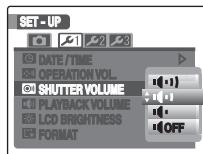

① Press ▲ or ▼ to select the menu.



② Press ►.  
Different type of screen appears depending on selected item.

























③ Press ▲ or ▼ to change the setting.



④ Press MENU/OK to confirm the setting.

## [SET-UP] menu option

	Setting	Display	Factory default	Explanation	Page
	 IMAGE DISP.]	[CONTINUOUS]/[3 SEC]/[1.5 SEC]/[ZOOM (CONTINUOUS)]/[OFF]	[1.5 SEC]	Sets the way for displaying the check image screen (photograph result) after taking a picture. The color tones in images recorded may differ from actual color. Playback the recorded images to check them.	114
	 FRAME NO.]	[CONTINUOUS]/[RENEW]	[CONTINUOUS]	Specifies whether frame numbers are assigned consecutively from previous numbers or begin again.	115
	 AF ILLUMINATOR]	[ON]/[OFF]	[ON]	Specifies whether the AF-assist illuminator is [ON] or [OFF].	34
	 DIGITAL ZOOM]	[ON]/[OFF]	[OFF]	Specifies whether digital zoom is used.	116
	 EVF/LCD MODE]	[30fps]/[60fps]	[30fps]	Sets the screen display to the fine mode.	–
	 DATE/TIME]	–	–	Corrects the date or time.	24
	 OPERATION VOL.]	 /  /  /  /[OFF]		Sets the volume of the tone emitted when the camera controls are used.	–
	 SHUTTER VOLUME]	 /  /  /  /[OFF]		Sets the volume of the sound emitted when the shutter operates.	–
	 PLAYBACK VOLUME]	–	7	Sets the volume of playing back movie and voice memo.	116
	 LCD BRIGHTNESS]	–	0	Sets the LCD monitor brightness.	117
	 FORMAT]	–	–	Initializes a Memory Card or internal memory. Select this menu to erase all the frames (files).	117



	Setting	Display	Factory default	Explanation	Page
	[言語/LANG.]	[日本語]/[ENGLISH]/ [FRANCAIS]/[DEUTSCH]/ [ESPAÑOL]/[ITALIANO]/ [中文簡]/[繁體]/[한글]/ [PYCCKИЙ]/[PORTUGUÊS]/ [NEDERLANDS]/[TURKÇE]/ [ČESKY]/[MAGYAR]/ [POLSKI]/[SVENSKA]	[ENGLISH]	Specifies the language used for screen display.	25
2	[AUTO POWER OFF]	[5 MIN]/[2 MIN]/[OFF]	[2 MIN]	Sets the time of turning camera off when camera is not used.	118
	[TIME DIFFERENCE]	🏠/➕	🏠	Specifies the time difference settings.	118
	[BACKGROUND COLOR]	-	-	Specifies the colors of menu, background, the boxes of Zoom bracketing, the box of Instant Zoom and so on.	-
	[DISCHARGE]	-	-	Discharges Ni-MH batteries.	138
	[VIDEO SYSTEM]	[NTSC]/[PAL]	-	Specifies whether video output is set to [NTSC] or [PAL].	-
3	[RESET]	-	-	Resets all the camera settings (other than the [DATE/TIME], [TIME DIFFERENCE], [BACKGROUND COLOR], and [VIDEO SYSTEM]) to the factory default values set at shipment. A confirmation message appears when you press ▶. To reset the camera settings, press ◀ or ▶ to select [OK] and press MENU/OK.	-

Continued ➡

**[IMAGE DISP.]**

Use this setting to specify the way for displaying the check image screen (photograph result) after taking a picture.

**[CONTINUOUS]:**

The results are always displayed after you shoot. Press the MENU/OK to take another picture.

**[3 SEC]/[1.5 SEC]:**

The image appears for about 3 or 1.5 seconds and is then recorded.

**[ZOOM (CONTINUOUS)]:**

The image appears enlarged. Use this mode to check details of image.

**[OFF]:**

The results are not displayed.

**! CAUTION**

- The color tones in images displayed when [3 SEC] or [1.5 SEC] is selected may differ slightly from those in the images actually recorded.
- [IMAGE DISP.] cannot be used when [LONG PERIOD] (→p.70) is set.

**MEMO**

When a result is displayed with [CONTINUOUS] set, overexposed areas in an image can be checked by pressing .

**■ Enlarging images**

Navigation screen  
(Current displayed image)



- ① Turn to W or T to zoom in or out of an image.





- ② Press ▲, ▼, ◀, or ▶ to display another part of the image.



- ③ Press MENU/OK to take another picture. The image is recorded automatically.

**MEMO**

- When  quality setting is selected, the image cannot be enlarged.
- Pressing DISP/BACK cancels the zoom setting.
- This function is disabled when setting the continuous shooting.
- This function is disabled when selecting .

**Intelligent Face Detection**

Images taken with the Intelligent Face Detection (→p.29). Press  (Intelligent Face Detection) to alternate between the displayed faces. Turn the zoom lever to T or W to zoom in or out the selected face. Press ▲, ▼, ◀ or ▶ to display another part of the image.

**[FRAME NO.]**

Use this function to specify whether frame numbers are assigned consecutively from previous numbers or begin again.

	[CONTINUOUS]	[RENEW]
<b>A</b>	0001 ⋮ 0005	0001 ⋮ 0005
↓		
<b>B</b>	0006 ⋮ 0010	0001 ⋮ 0005

\* Formatted Memory Card or internal memory used for both A and B.

**[CONTINUOUS]:**

Pictures are stored beginning from the highest file number stored on the last Memory Card or internal memory used.

**[RENEW]:**

Pictures are stored on each Memory Card beginning with a file number 0001. Each image will be numbered consecutively from the last number used. So when recorded images in the Memory Card are erased, the number of the erased frame will not be used again.

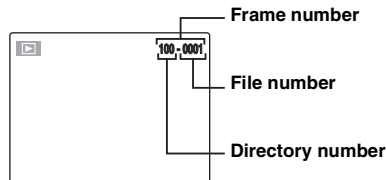
**✓ CHECK**

The last 4 digits of the 7-digit number in the top right corner of the screen are the file numbers, while the first 3 digits show the directory number.

**📄 MEMO**

- Setting this function to [CONTINUOUS] makes file management easier as it makes sure that file names are not duplicated when images are downloaded to a PC.
- When the camera settings are [📷 RESET] (→p.113), the frame number setting ([CONTINUOUS] or [RENEW]) is changed to [CONTINUOUS] and the frame number itself does not return to 0001.
- In [CONTINUOUS] setting, images are stored beginning from the highest file number on the current Memory Card when the Memory Card already contains image files with file numbers higher than the highest file number on the last Memory Card.
- The displayed frame number may differ for images photographed on other cameras.

**Continued** ➡

**[DIGITAL ZOOM]**

Use this function to shoot enlarged images than maximum optical zoom scale.

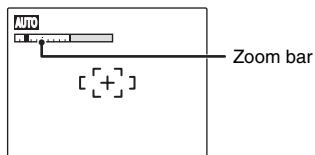
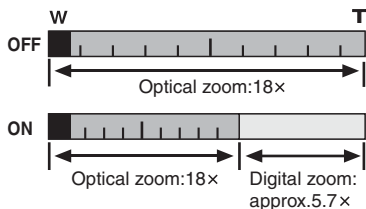
**■ Zoom bar display****MEMO**

When zooming changes between optical and digital, the position of the "■" indicator stops. Turn the zoom lever again to start the "■" indicator moving again.

**! CAUTION**

Using the digital zoom allows you to enlarge your subject and shoot it. However, it will lower your image quality. Set the digital zoom when requiring it.

**[PLAYBACK VOLUME]**

Use this function to adjust volume while playing back movie and voice memo.

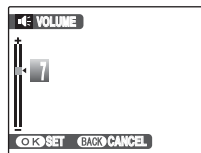

- ① Press ▲ or ▼ to adjust the volume.  
The larger the number, the larger the volume is emitted. 0 (zero) indicates a sound deadening.
- ② Press MENU/OK to confirm the setting.

**[LCD BRIGHTNESS]**

Use this function to adjust the screen brightness.

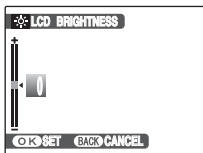

- 1 Press ▲ or ▼ to adjust the screen brightness.  
The indicator moves to the + to display the screen brightly or to the – to darken the screen.
- 2 Press MENU/OK to confirm the setting.

**[FORMAT]**

Initialize (format) the Memory Card or internal memory for use with the camera.

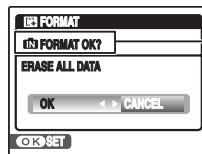

Place of initialize  
 [ ] FORMAT OK?:  
 Internal memory  
 [ ] FORMAT OK?:  
 Memory Card



- 1 Press ◀ or ▶ to select [OK].



- 2 Pressing MENU/OK initializes the Memory Card or internal memory.

**! CAUTION**

- The Format function erases all the frames (files), including protected frames (files). Back up important frames (files) onto your PC or another media.
- Do not open the battery cover or slot cover during formatting. The Memory Card or internal memory could be damaged.

**Continued** ➔

**[AUTO POWER OFF]**

When this function is active and the camera remains unused for 2 or 5 minutes, it turns camera off. Use this function when you want to get the maximum possible running time from your batteries.

**! CAUTION**

The Auto power off function is disabled during slide show (→p.91), discharging rechargeable batteries (→p.138), and when a printer or a PC connection (→p.122, 131) is being used.

**MEMO To restore power to the camera**

Refer to "Turning On and Off" (→p.21).

**[TIME DIFFERENCE]**

Use this function when traveling to destinations in different time zones. This function sets a time difference relative to the date and time currently set. When this setting is enabled, the specified time difference is applied when pictures are taken.

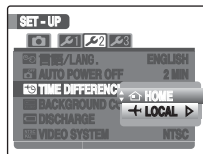
**1 Use Time difference function.**

Press ▲ or ▼ to change between [HOME] and [LOCAL].

To set the time difference, select [LOCAL].

[HOME]:Your home time zone

[LOCAL]:Your destination time zone

## 2 Move to [TIME DIFFERENCE] screen.

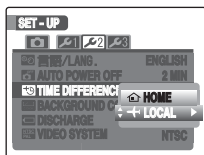

Press ►.

## 3 Set time difference.

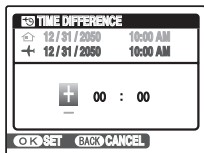

① Press ◀ or ▶ to select +/–, hour, and minute.



② Press ▲ or ▼ to change the setting.



③ Always press MENU/OK after the settings are completed.

### ✓ CHECK

#### Available time setting

–23:45 to +23:45 (in 15-minute increments)



### MEMO

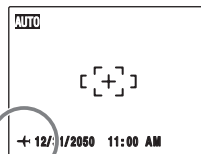

In the time difference setting, when you change to the Shooting mode, + and the date is displayed for 3 seconds, the date display turns yellow.

### ✓ CHECK

Upon returning from a trip, always change the time difference setting back to [HOME] and then check the date and time again.

# Connecting to a TV

When connecting to a TV, images can be displayed on wider screen. Using slide show function (→p.91) together, you can have fun with folks.

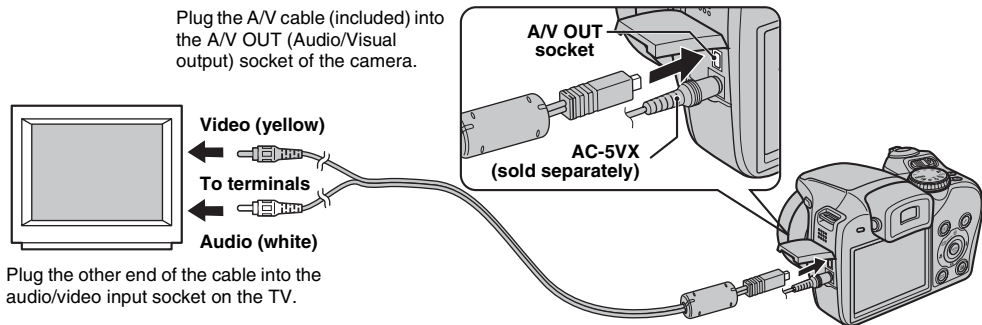

## ⚠ CAUTION

- Plug the A/V cable (included) and the AC power adapter correctly and push them in each terminal.
- See "Notes and Cautions" (included) for notes on the AC power adapter.

## 📄 MEMO

- When connecting the A/V cable (included) to TV, the camera's screen is turned off.
- The image quality for movie playback is lower than for still images.
- When connecting to a TV, even if you adjust the volume from the [🔊] PLAYBACK VOLUME], the TV volume cannot be changed. Refer to the instructions provided with your TV for more information on audio/video input for your TV.
- Use the AC-5VX (sold separately) when FinePix S8100fd is connected to a TV for long periods.



## Using the AC power adapter (sold separately)

Always use a FUJIFILM AC Power Adapter AC-5VX (sold separately) (→p.136).

Use the AC power adapter to prevent losing power at inconvenient times, such as when downloading photographed images to your PC. You can take pictures and play back images without worrying about depleting the batteries.

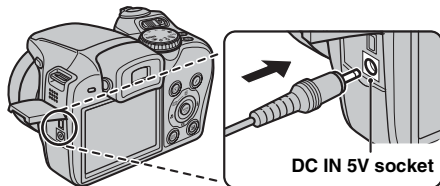

Check that the camera is off. Plug the AC power adapter connector into the DC IN 5V socket and then plug the AC power adapter into the power outlet.

### ⓘ CAUTION

- Only connect and disconnect the AC power adapter when the camera is off. Connecting or disconnecting the AC power adapter while the camera is on temporarily interrupts the power supply to the camera, which will stop the recording of any images or movies being shot. Failing to turn the camera off before connecting/disconnecting can also result in damage to the Memory Card, or malfunction during PC connection.
- The socket-outlet shall be installed near the equipment and shall be easily accessible.
- The shape of the plug and socket-outlet depends on the country of use.
- FUJIFILM is not responsible for any malfunction caused by using any AC power adapter other than FUJIFILM AC Power Adapter AC-5VX.
- Do not connect the AC power adapter to charge the AA-size Ni-MH (nickel-metal hydride) batteries. Use the optional charger to charge the Ni-MH batteries.
- See "Notes and Cautions" (included) for notes on the AC power adapter.

# Connecting Camera Directly to Printer — PictBridge Function



When a printer that supports PictBridge is available, images can be printed by connecting the camera directly to the PictBridge-compatible printer without a PC.

## Connecting to a printer

- 1 Connect the camera to your printer using the USB cable.

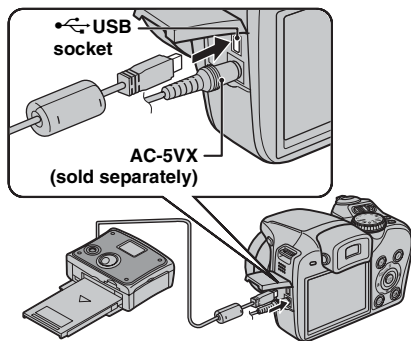

### MEMO

Use the AC-5VX (sold separately) when FinePix S8100fd is connected to a printer.

- 2 Connect the camera to a printer and turn the printer on.  
Press for about 1 second to turn the camera on.

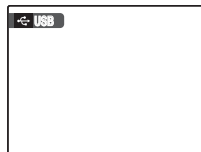

[USB] appears on the screen.

- 3 The following screen appears on the screen after a moment.

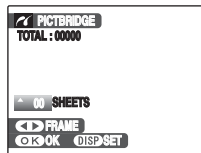

"Specifying images for printing"  
→p.123  
"Printing with DPOF setting"  
→p.124

### MEMO

Depending on the printer, some functions are disabled.

## Specifying images for printing ([PRINT WITH DATE] / [PRINT WITHOUT DATE])

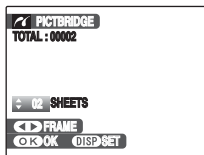

- 1 Press ◀ or ▶ to display the frame (file) for specifying PRINT setting.



- 2 Press ▲ or ▼ to set a value.  
Up to 99 sheets are printed.

To specify more PRINT settings, repeat steps ① and ②.



- 3 Press MENU/OK to display the confirm setting.

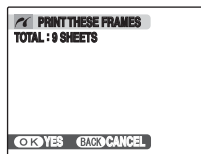

- 4 Press MENU/OK again to download the data to the printer and start printing the specified number of prints.





### MEMO

Even if MENU/OK is pressed with total number of images set at 0 (zero), the screen printing once appears on the screen. Press MENU/OK again and printing starts.

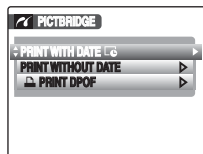

### MEMO Printing with date



- 1 Press DISP/BACK to display the setting display.
- 2 Press ▲ or ▼ to select [PRINT WITH DATE] .
- 3 Press MENU/OK.



### CAUTION

[PRINT WITH DATE 

## Printing with DPOF setting [PRINT DPOF]

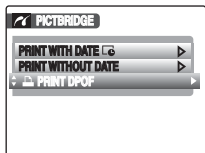

① Press DISP/BACK to open the menu.



② Press ▲ or ▼ to select [PRINT DPOF].



③ Press MENU/OK to display the confirm setting.

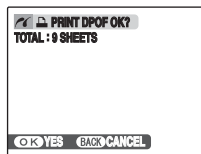

④ Press MENU/OK again to download the data to the printer and start printing the specified frames (files) continuously.

### CHECK

To select [PRINT DPOF], the DPOF settings must be specified on FinePix S8100fd beforehand (→p.91).

### CAUTION

Even when [WITH DATE] is specified in the DPOF settings (→p.91), the date is not inserted on printers that do not support date printing.

## MEMO

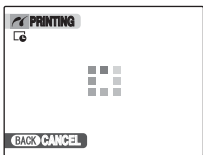

Press DISP/BACK to cancel the printing.  
Depending on the printer, the printing may not be canceled immediately or printing may stop midway through.  
When printing stops midway, briefly turn the camera off and then on again.

### ***Disconnecting the printer***

- ① Check that [PRINTING] is not displayed on the camera's screen.
- ② Turn the camera off. Unplug the USB cable.

## MEMO

DPOF setting can be specified for images on internal memory.

### CAUTION

- In PictBridge function, images photographed on other than a camera may not be printed.
- The camera cannot be used to specify printer settings such as the paper size and print quality.
- Please connect the AC Power Adapter AC-5VX (sold separately) to your camera.
- Use internal memory or a Memory Card that was formatted on FinePix S8100fd.
- Movies cannot be printed.
- Images photographed with a camera other than FinePix S8100fd may not be printed.

# Installation on a Windows PC

## Pre-installation checklist

### ■ Hard ware (software) requirements and recommended system

To run this software, you must have the hardware and software described below. Check your system before you begin the installation.

requirement		Recommendation	
Operating System*1	Windows 98 SE Windows Millennium Edition (Windows Me) Windows 2000 Professional*2/Windows 2000 SP4*2 Windows XP Home Edition*2/Windows XP SP2*2 Windows XP Professional*2 Windows Vista*2	Windows Vista	Windows XP
CPU	200 MHz Pentium minimum (Windows Vista/XP users: 800MHz Pentium 4 or better recommended)	3 GHz Pentium 4 or better	2 GHz Pentium 4 or better
RAM	128 MB minimum (512 MB minimum for Windows Vista/XP)	1 GB or better	512 MB or better
Hard disk space	Amount required for installation: 450 MB minimum Amount required for operation: 600 MB minimum	15 GB or better	2 GB or better
Display	800 × 600 pixels or better, 16-bit color or better	1024 × 768 pixels or better, Highest (32 bit)	

\*1 Models with one of the above operating systems pre-installed.

\*2 When you install the software, login using a system administrator account (e.g. "Administrator").

### ! CAUTION

- Additional USB interface board is not guaranteed.
- Windows 95, Windows 98 and Windows NT cannot be used.
- Operation is not guaranteed on home-built PCs or on PCs running updated operating system software.
- When you reinstall or remove FinePixViewer, the Internet menu and your user ID and password for the FinePix Internet Service are deleted from your PC. Click the [Register now] button, enter your registered user ID and password and download the menu again.

**Do not connect the camera to your PC until the software installation is completed.**

**1 Install FinePixViewer as instructed by the on-screen instructions.**

**Launching the installer manually**

- ① Double-click the [My Computer] icon.  
\* Windows XP users should click [My Computer] in the [Start] menu.  
Windows Vista users should click [Computer] in the [Start] menu.
- ② Right-click [FINEPIX] (CD-ROM drive) in the [My Computer] window (Windows Vista users: in the [Computer] window) and select [Open].
- ③ Double-click [SETUP] or [SETUP.exe] in the CD-ROM window.



- \* The way file names are displayed differs as described below depending on your PC settings.
- File extensions (3-letter suffixes indicating the file type) may be shown or hidden. (e.g. Setup.exe or Setup)
  - Text may be shown normally or all in uppercase (e.g. Setup or SETUP).

**For Windows Vista users:**

When loading the bundled CD-ROM on your PC, the [AutoPlay] window may appear. In this case, click [SETUP.exe].

When [User Account Control] window appears, click [Allow].

**2 Install DirectX as directed by the on-screen instructions and then restart your PC. If the latest version of DirectX is already installed on your PC, this installation is not performed.**

**! CAUTION**

- If the latest version of DirectX or Windows Media Player has not been installed, each software will be installed, and then the PC will restart.
- Do not remove the CD-ROM during this procedure.

**3 After restarting the PC, a message appears stating [Installation of the FinePixViewer has been completed]. Remove the CD-ROM from your PC.**

# Installation on a Mac OS X

## Pre-installation checklist

### ■ Hardware and software requirements

To run this software, you must have the hardware and software described below. Check your system before you begin the installation.

<b>Compatible Mac</b> *1	Power Macintosh G3*2, PowerBook G3*2, Power Macintosh G4, iMac, iBook, Power Macintosh G4 Cube, PowerBook G4, Power Macintosh G5, MacBook, MacBook Pro, Mac mini, or Mac PRO
<b>Operating System</b>	Mac OS X (compatible with version 10.3.9 to 10.4.10)
<b>RAM</b>	256 MB minimum
<b>Hard disk space</b>	Amount required for installation: 200 MB minimum Amount required for operation: 400 MB minimum
<b>Display</b>	800 × 600 pixels or better, at least 32,000 colors

\*1 PowerPC, Intel processor loaded

\*2 Models with a USB port as a standard feature

### CAUTION

- Connect the camera directly to the Macintosh using the USB cable (included). The software may not operate correctly if you use an extension cable or connect the camera via a USB hub.
- Push the USB connector fully into the socket to ensure that it is securely connected. The software may not operate correctly if the connection is faulty.
- Additional USB interface board is not guaranteed.



- 1** Turn your Macintosh on and start up Mac OS X. Do not launch any other applications.
- 2** When the bundled CD-ROM is loaded into the CD-ROM drive, the [FinePix] icon appears. Double-click the [FinePix] icon to open the [FinePix] volume window.
- 3** Double-click on [Installer for MacOSX].
- 4** The Installer setup dialog appears. Click the [Installing FinePixViewer] button.

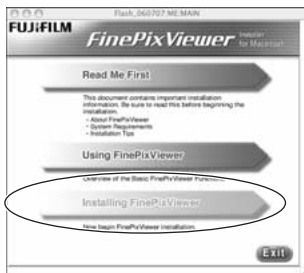

**!** **CAUTION**

For more information on what is installed, click the [Read Me First] button and [Using FinePixViewer] button.

- 5** The [Authenticate] dialog appears. Enter the name and password for the administrator account and then click the [OK] button.\*

\* The administrator account is the user account used for Mac OS X installation and you can confirm the user account in the Accounts dialog in the System Preferences.

- 6** Install FinePixViewer as directed by the on-screen instructions.

*Continued* ➔

**7** The [FinePixViewer installation completed] message dialog appears. Then click exit button and close it.

**!** **CAUTION**

When Safari is used as the Web browser, a message may be displayed and the CD-ROM may not be removed. If this happens, click the Safari icon in the Dock to make Safari the active application and then select [Quit Safari] in the [Safari] menu to shut down Safari.

**8** Launch [Image Capture] from the [Applications] folder.

**9** Change the Image Capture settings. Select [Preferences...] from the [Image Capture] menu.



**10** Select [Other...] from [When a camera is connected, open].

**11** Select [FPVBridge] from [FinePixViewer] folder in the [Applications] folder and click the [Open] button.



**12** Select [Quit Image Capture] menu in the [Image Capture] menu.

# Connecting to a PC

By connecting the camera to a PC, your system can be expanded to fill a wide range of uses. Using "FinePixViewer" performs images saving, browsing and file management etc.

## FinePixViewer Overview

Enables importing images, managing files and folders, and ordering prints using the internet (only Windows users).

### ! CAUTION

The Windows CD-ROM may also be required during installation. In this event, change CD-ROMs as directed by the on-screen instructions.

**Refer to Software Installation (→p.126, 128) the first time you connect the camera to your PC.**

Install the software first. Do not connect the camera to the PC before installing all the software.



**CD-ROM**  
(Software for FinePix)

- 1 Insert the Memory Card with images into the camera (→p.18).

You can use the **xD-Picture Card** and the SD Memory Card with the FinePix S8100fd.

In this Owner's Manual, these cards are expressed as "Memory Card".

### ! CAUTION

- Do not format the Memory Card in the camera on the PC.
- Use the Memory Card with images taken by a FUJIFILM Digital camera.

- 2 Connect the camera to your PC using the USB cable (included).

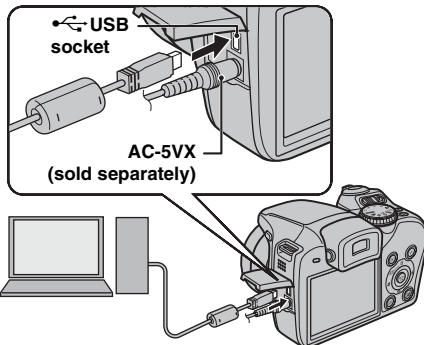

- 3 Press  for about 1 second to turn the camera on in Playback mode.

- 4 Set your PC



### MEMO

In Windows, if FinePixViewer is already installed, the driver will be set automatically. No action is required.

**Continued** ➔

**!** **CAUTION**

- FinePix S8100fd is compatible with PTP (Picture Transfer Protocol)/MTP (Media Transfer Protocol). A PTP/MTP-compatible camera is a camera that can recognize the PC and printer automatically when connected.
- Do not disconnect the USB cable (included) when the camera is communicating with a PC. If the USB cable (included) is disconnected during communication, the files on the Memory Card or internal memory may be damaged.
- In Mac OS X, you must set automatic setup the first time you connect the camera to your PC.
- When the camera and PC are exchanging data, the indicator lamp blinks alternately green and orange.
- Auto power off is disabled during USB connection.
- Before replacing the Memory Card, always disconnect the camera from the PC.
- The camera and PC may be exchanging data even when [Copying] disappears from your PC screen. Before disconnecting the USB cable (included), always check that the indicator lamp is off.
- Always use FinePixViewer to transfer images with voice memos to a PC.
- The cost of an Internet provider for connecting to the internet is the user's responsibility.
- When using FinePixViewer to save images on a data server (network), FinePixViewer may not run as it would in a standalone PC environment.

**!** **CAUTION**

- Always use the FUJIFILM AC Power Adapter AC-5VX (sold separately). If the camera suddenly loses power during data exchange, data exchange will not be performed correctly, and the Memory Card or internal memory could be damaged.
- Make sure that the USB cable (included) is connected correctly and securely.
- Connect the camera directly to the PC using the USB cable (included). The software may not operate correctly when you use an extension cable, or if you connect the camera via a USB hub.
- When your PC has more than one USB port, the camera can be connected to either port.
- When Windows 98 SE is used, the supplied software must be installed first before connecting the camera to a PC using the USB cable. The PC will not recognize the camera if it is connected before installation.
- A memory Card, the internal memory, data in a Memory Card or data in the internal memory could be damaged if any of the following are performed;
  - the USB cable is disconnected
  - ON/OFF switch or buttons are pressed

---

## The following steps differ depending on the PC's operating system (Windows XP/Vista and Mac OSX case)

When your PC recognizes the camera automatically, FinePixViewer automatically starts up and the Save Image Wizard window (Save Image dialog box) appears. Follow the instructions provided on screen to save the images. To proceed without saving the images, click the [Cancel] button.

### CAUTION

When there are many images stored on a Memory Card, it takes a while to display on the screen of your PC. Also, it may take a while to import images or you may be unable to save images. In this case, use an Image Memory Card Reader.

### MEMO

- Images in the camera cannot be seen directly with FinePixViewer. Save images on a PC.
- If you cancel saving by clicking the [Cancel] button, slide the power switch to turn off the camera and then disconnect it from the PC.
- When the camera is connected to your PC, FinePixViewer automatically starts up by the function of Exif Launcher, which is installed in FinePixViewer.

Proceed to "Using FinePixViewer" (→p.134).

### CAUTION (MAC OS X)

If FinePixViewer does not start up automatically, the software may not be installed correctly. Set your PC again after disconnecting the camera and restart.

### CAUTION (MAC OS X) Note on disconnecting the camera

- Close all files in the camera, and make sure the camera is not exchanging data.
- The camera and PC may be exchanging data even when [Copying] disappears from your PC screen, especially in the case of copying large data amounts. Do not disconnect the USB cable (included), immediately after this message has disappeared. Always check that the indicator lamp is off first before disconnecting.

## Using FinePixViewer

### Mastering FinePixViewer

For all information on FinePixViewer functions, refer to [How to Use FinePixViewer] in the Help menu for details.

• **What is explained in [How to Use FinePixViewer]...**  
 [How to Use FinePixViewer] covers a range of topics, including batch processing and ordering prints.

#### Example: Looking up slide shows

- ① Click [How to Use FinePixViewer] in the FinePixViewer Help menu.
- ② Click [Basic Operation] and then click [Slide Show] in the menu that appears.
- ③ The [Slide Show] information appears. Press the [<<<] key to view the previous page or the [>>>] key to view the next page.

### Uninstalling the software

Only perform this operation when you no longer require the installed software or when the software was not installed correctly.

#### Windows

- ① Check that the camera is not connected to the PC.
- ② Quit all currently running applications.
- ③ The steps for uninstalling software differ depending on the operating system. Follow the steps for each operating system to uninstall the software listed below.

The following software is to be uninstalled:

- FinePixViewer
  - FinePix Resource
  - FinePix Studio\*
  - RAW FILE CONVERTER LE\*
- \* May not have been installed depending on the operating system.

To remove FinePixViewer

FinePixViewer Ver.5.\*

To remove the driver software

FUJIFILM USB Driver



- ④ When the message appears, click the [OK] button.  
 Check your selection carefully since the process cannot be canceled once you click the [OK] button.



#### Macintosh

Quit FinePixViewer. Then drag the installed FinePixViewer folder to the Trash and select [Empty Trash] in the [Finder] menu.

# System Expansion Option

By using FinePix S8100fd together with other optional FUJIFILM products, your system can be expanded to fill a wide range of uses.

Accessory availability may vary by country. Please check with your local Fujifilm representative to confirm product availability.

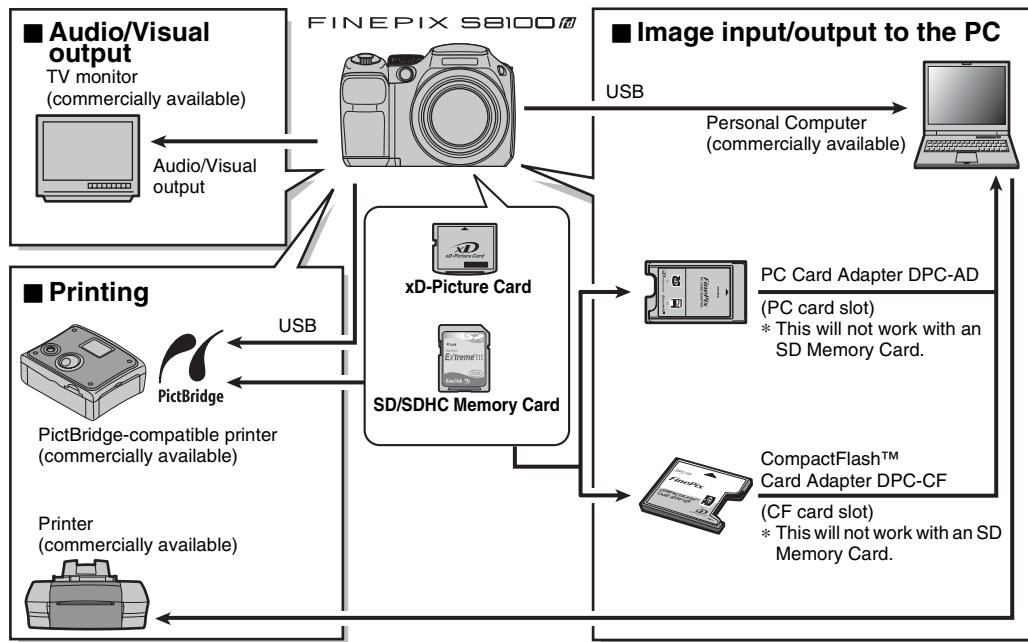

# Accessories Guide

Visit the FUJIFILM web site for the latest information on camera accessories.

[http://www.fujifilm.com/products/digital\\_cameras/index.html](http://www.fujifilm.com/products/digital_cameras/index.html)

Accessory availability may vary by country. Please check with your local Fujifilm representative to confirm product availability.

## • **xD-Picture Card**

Use the following **xD-Picture Cards**:

256MB/512MB/1GB/2GB

There are two types of **xD-Picture Card**: standard type and Type M (containing "M" in the model number, such as DPC-M1GB).

FinePix S8100fd is compatible with Type M, however they may not be compatible depending on the device used (Image Memory Card Reader, etc.).



## • **AC Power Adapter AC-5VX**

Use the AC-5VX when taking pictures or play back images for long periods or when FinePix S8100fd is connected to a PC.

\* The shape of the AC power adapter, the plug, and power outlet depend on the country.

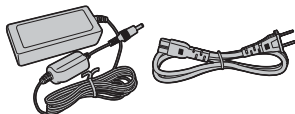

## • **PC Card Adapter DPC-AD**

The PC Card Adapter allows the **xD-Picture Card** and SmartMedia to be used as a PC Card Standard ATA-compliant (PCMCIA 2.1) PC card (Type II).

-Compatible with **xD-Picture Card** of 16 MB to 512 MB, and SmartMedia of 3.3 V, 2 MB to 128 MB.

\* This is not compatible with the SD Memory Card.



## • **CompactFlash™ Card Adapter DPC-CF**

Loading an **xD-Picture Card** into this adapter allows you to use the card as a CompactFlash card (Type I).

\* This is not compatible with the SD Memory Card.





# Using Your Camera Correctly

Read this information and the “Safety Notes” (→ “Notes and Cautions” (included)), to make sure you use your camera correctly.

## ■ Places to Avoid

Do not store or use the camera in the following types of locations:

- In the rain or in very humid, dirty, or dusty places
- In direct sunlight or in places subject to extreme temperature rises, such as in a closed car in summer
- Extremely cold places
- Places with strong vibration
- Places with smoke or steam
- Places subject to strong electric magnetic fields (such as near broadcasting tower, power lines, radar, motors, transformers, magnets, etc.)
- In contact with chemicals such as pesticides
- Next to rubber or vinyl products

## ■ Damaged by Water or Sand

FinePix S8100fd can be damaged on the inside and outside by water and sand. When you are at the beach or close to water, make sure that the camera is not damaged by water or sand. Take care not to place the camera on a wet surface.

## ■ Damaged by Condensation

If the camera is carried from a cold location into a warm place, water droplets (condensation) may form on the inside of the camera or on the lens. When this occurs, turn the camera off and wait an hour before using the camera. Condensation may also form on the Memory Card. In this event, remove the Memory Card and wait a short time.

## ■ When the Camera is Not Used or is stored Periods of Time

If you do not intend to use the camera for a long period of time, remove the batteries and the Memory Card.

## ■ Cleaning Your Camera

- Use a blower brush to remove any dust on the lens, LCD monitor or viewfinder, and then gently wipe the camera with a soft, dry cloth. If any soil remains, apply a small amount of lens cleaning liquid to a piece of FUJIFILM lens cleaning paper and wipe gently.
- Do not scratch hard objects against the lens, LCD monitor or viewfinder.
- Clean the body of the camera with a soft, dry cloth. Do not use volatile substances or cleaning products these items can cause damage.

## ■ Using the Camera When Traveling

When traveling overseas, do not place your camera in the check-in baggage. Baggage can be subjected to violent shocks, and the camera may be damaged inside or outside.

# Discharging rechargeable batteries

The Discharging rechargeable batteries function can only be used with Ni-MH batteries.

The Discharging rechargeable batteries function should not be used with alkaline batteries as it will completely drain the battery charge.

Use the Discharging rechargeable batteries function in the following situations:

- When the batteries only last for a short time after being charged normally
- When the batteries have not been used for a long period
- When you purchase new Ni-MH batteries

Do not use the Discharging rechargeable batteries function while using the AC power adapter. In these situations, the Ni-MH batteries will not be discharged due to the external power supply.

To discharge rechargeable batteries:

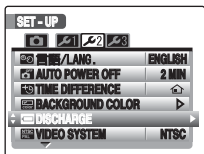

- ① Press to turn the camera on.



- ② Press MENU/OK to display the menu on the screen.



- ③ Press or to select [SET SET-UP].



- ④ Press to display the [SET-UP] menu.



- ⑤ Press or to select .



- ⑥ Press or to select [DISCHARGE].

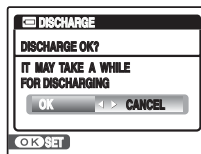

- ⑦ Press .



- ⑧ Press MENU/OK.



- ⑨ Press or to select [OK].



- ⑩ The screen changes and discharging begins. When the battery level indicator blinks red and discharging ends, the camera turns off.

## ! CAUTION

To cancel discharging, press DISP/BACK.

# Notes on the xD-Picture Card™, the SD Memory Card and the Internal Memory

## ■ Handling Memory Card

- When inserting the Memory Card into the camera, hold the Memory Card straight as you push it in.
- Never remove the Memory Card or turn the camera off during data recording or erasing (Memory Card formatting) as this could be damaged to the Memory Card.
- The use of **xD-Picture Cards** is recommended with FinePix S8100fd. The recording quality cannot be guaranteed when **xD-Picture Cards** other than those manufactured by FUJIFILM are used.
- The Memory Card may feel warm when it is removed from the camera after taking pictures. This is normal.
- Do not put labels on the Memory Card. Peeling labels can cause the camera not to work properly.



## MEMO Type M and H of xD-Picture Card

- Type M  
There are two types of Memory Card: standard type and Type M (containing "M" in the model number, such as DPC-M2GB). FinePix S8100fd is compatible with Type M.
- Type H  
Type H and M share the same compatibility.
- Usable USB drive  
Type H cannot be used with **xD-Picture Card** USB drive DPC-UD1, while Type M can.

## ■ Internal Memory





- Images held in the camera's internal memory may be corrupted or erased due to problems such as camera faults. Save your important data to another media (i.e., DVD-R, CD-R, CD-RW, hard disk, etc.).
- Data stored in the camera's internal memory cannot be guaranteed in the event that the camera is submitted for repairs.
- When the camera is repaired, any data stored in the camera's internal memory is subject to checking by the repairer.





## ■ Using Memory Card or Internal Memory with a PC

- When taking pictures using a Memory Card or internal memory that has been used on a PC, reformat the Memory Card using your camera.
- When formatting, a directory (folder) is created. Image data is then recorded in this directory.
- Do not change or delete the directory (folder) or file names on the Memory Card or internal memory because this will make it impossible to use the Memory Card or internal memory in your camera.
- Always use the camera to erase image data.
- To edit image data, copy or transfer the image data to the PC and edit the copied or transferred data.

# Warning Displays

The table below lists the warnings that are displayed on the screen.

Warning Displayed	Explanation	Remedy
 (Lit red)  (Blinking red)	The batteries are low or completely out of charge.	Load new or fully charged batteries.
	There is a strong likelihood of camera shake because the shutter speed is slow.	Use flash photography. A tripod may be recommended, depending on the scene and mode.
 <p>*The shape of the AF frame differs depending on the setting in the [SHOOTING MENU].</p>	The AF (autofocus) cannot work effectively.	<ul style="list-style-type: none"> <li>• If the image is too dark, take the picture at a distance of around 2 m (6.6 ft.) from the subject.</li> <li>• Use AF lock to take the picture (→p.33).</li> <li>• Select Macro mode when taking close-up shots.</li> </ul>
<b>Aperture/ Shutter speed display</b> (Lit red)	The camera cannot shoot the picture at the correct brightness due to too bright or dark shooting condition.	The picture can be taken, but the correct brightness (exposure) will not be obtained.
<b>[FOCUS ERROR]</b>  <b>[LENS CONTROL ERROR]</b>  <b>[ZOOM ERROR]</b>	<ul style="list-style-type: none"> <li>• Camera malfunction or fault.</li> <li>• You are touching the autofocus ring.</li> </ul>	<ul style="list-style-type: none"> <li>• Turn the camera on again, taking care not to touch the lens.</li> <li>• Turn the camera off and on again. If the message still appears, contact your FUJIFILM dealer.</li> <li>• Do not hold the autofocus ring. The lens will automatically refocus when you release the autofocus ring.</li> </ul>
<b>[NO CARD]</b>	Memory Card is not inserted when transferring images.	Insert a Memory Card.
<b>[CARD NOT INITIALIZED]</b>	<ul style="list-style-type: none"> <li>• The Memory Card or internal memory is not formatted.</li> <li>• The Memory Card was formatted on a PC.</li> <li>• The Memory Card contact area is soiled.</li> <li>• Camera fault.</li> </ul>	<ul style="list-style-type: none"> <li>• Format the Memory Card or internal memory on the camera (→p.117).</li> <li>• Format the Memory Card on the camera.</li> <li>• Wipe the contact area on the Memory Card with a soft, dry cloth. It may be necessary to format the Memory Card (→p.117). If the message still appears, replace the Memory Card.</li> <li>• Contact your FUJIFILM dealer.</li> </ul>

Warning Displayed	Explanation	Remedy
[CARD ERROR]	<ul style="list-style-type: none"> <li>The Memory Card contact area is soiled.</li> <li>The Memory Card format is incorrect.</li> <li>Camera fault.</li> <li>The Memory Card is damaged.</li> <li>Inserted Memory Card is not compatible with your camera.</li> </ul>	<ul style="list-style-type: none"> <li>Wipe the contact area on the Memory Card with a soft, dry cloth. It may be necessary to format the Memory Card (→p.117). If the message still appears, replace the Memory Card.</li> <li>Contact your FUJIFILM dealer.</li> <li>Insert a compatible Memory Card that is operation-checked at FUJIFILM Corporation.</li> </ul>
 MEMORY FULL  MEMORY FULL	The internal memory or Memory Card is full.	Erase some images in internal memory or Memory Card (→p.42), or use a Memory Card that has ample free space.
[WRITE ERROR]	<ul style="list-style-type: none"> <li>The data could not be recorded due to an Memory Card error or a connection error between the Memory Card and camera.</li> <li>The image cannot be recorded as it is too large to fit in the available space on the Memory Card.</li> <li>The Memory Card or internal memory is not formatted.</li> </ul>	<ul style="list-style-type: none"> <li>Re-insert the Memory Card or turn the camera off and then on again. If the message still appears, contact your FUJIFILM dealer.</li> <li>Use a new Memory Card.</li> <li>Format the Memory Card or internal memory on the camera (→p.117).</li> </ul>
[PROTECTED CARD]	The SD Memory Card switch is slide to the "Lock" side.	Unlock the protection by sliding it back (→p.19)
[INTERNAL MEMORY IS FULL INSERT A NEW CARD.]	The data could not be recorded or copied since the internal memory is full.	Erase some images from the internal memory (→p.42), or use a Memory Card that has ample free space.
[BUSY]	The timing for recording was incorrect because the Memory Card was formatted on a PC.	Use a Memory Card that was formatted on the camera.
[  CAN NOT EXECUTE]	An attempt was made to take a picture in [  AUCTION MODE] while  appeared in the LCD screen.	Load new or fully charged batteries.
[PRESS AND HOLD THE DISP BUTTON TO DEACTIVATE SILENT MODE]	An attempt was made to set sound in the Silent mode.	Sound cannot be set in the Silent mode. Release the Silent mode to set sound.

Warning Displayed	Explanation	Remedy
[FRAME NO. FULL]	The frame number has reached 999-9999. No more pictures can be taken.	<ol style="list-style-type: none"> <li>① Insert a formatted Memory Card into the camera.</li> <li>② Set [RENEW] as the [FRAME NO.] setting in the [SET] SET-UP menu (→p.115).</li> <li>③ Start taking pictures (The frame number starts from "100-0001").</li> <li>④ Set [CONTINUOUS] as the [FRAME NO.] setting in the [SET] SET-UP menu.</li> </ol>
[READ ERROR]	<ul style="list-style-type: none"> <li>• The played back file was not recorded correctly.</li> <li>• The Memory Card contact area is soiled.</li> <li>• Camera fault.</li> <li>• An attempt was made to play back the image or the movie that was not recorded on this camera.</li> </ul>	<ul style="list-style-type: none"> <li>• This file cannot be played back.</li> <li>• Wipe the contact area on the Memory Card with a soft, dry cloth. It may be necessary to format the Memory Card (→p.117). If the message still appears, replace the Memory Card.</li> <li>• Contact your FUJIFILM dealer.</li> <li>• The movie and image cannot be played back.</li> </ul>
[TOO MANY FRAMES]	An attempt was made to show 5,000 or more image by date sorting.	No more than 4,999 images can be shown by date sorting.
[PROTECTED FRAME]	<ul style="list-style-type: none"> <li>• An attempt was made to erase a protected file.</li> <li>• An attempt was made to add a voice memo to protected file.</li> <li>• An attempt was made to rotate a protected file.</li> </ul>	<ul style="list-style-type: none"> <li>• Protected files cannot be erased. Remove the protection (→p.97).</li> <li>• Protected files cannot be added to voice memos. Remove the protection (→p.97).</li> <li>• Protected files cannot be rotated. Remove the protection (→p.97).</li> </ul>
[🔊 ERROR]	<ul style="list-style-type: none"> <li>• The voice memo file is faulty.</li> <li>• Camera fault.</li> </ul>	<ul style="list-style-type: none"> <li>• The voice memo cannot be played back.</li> <li>• Contact your FUJIFILM dealer.</li> </ul>
[📷 NO IMAGE] [📷 NO IMAGE]	An attempt was made to transfer images from the Memory Card or internal memory that memory was empty.	It is impossible to copy.
[📷 CAN NOT TRIM]	An attempt was made to trim a 0.3M image.	The image cannot be trimmed.
[CAN NOT TRIM]	<ul style="list-style-type: none"> <li>• An attempt was made to trim an image shot using a camera other than FinePix S8100fd.</li> <li>• The image is damaged.</li> </ul>	The image cannot be trimmed.

Warning Displayed	Explanation	Remedy
<b>[DPOF FILE ERROR]</b>	Prints were specified for 1000 or more frames in the DPOF frame settings.	The maximum number of frames for which prints can be specified on the same Memory Card is 999. Copy the images for which you want to order prints onto another Memory Card and then specify the DPOF settings.
<b>[CAN NOT SET DPOF]</b> <b>[CAN NOT SET DPOF]</b>	An attempt was made to specify DPOF settings for a movie or an image that is not supported by DPOF.	DPOF printing cannot be used with this image format.
<b>[CAN NOT ROTATE]</b> <b>[CAN NOT ROTATE]</b>	An attempt was made to rotate a movie or an image shot using a camera other than FinePix S8100fd.	These images cannot be rotated by image formats.
<b>[COMMUNICATION ERROR]</b>	The camera is not connected to a PC or printer.	<ul style="list-style-type: none"> <li>• Check that the USB cable is connected correctly.</li> <li>• Check that your printer is turned on.</li> </ul>
<b>[PRINTER ERROR]</b>	Displayed for PictBridge.	<ul style="list-style-type: none"> <li>• Check that the printer is not out of paper or out of ink.</li> <li>• Turn the printer off briefly and then turn it back on.</li> <li>• Refer to the user manual supplied with your printer.</li> </ul>
<b>[PRINTER ERROR RESUME?]</b>	Displayed for PictBridge.	Check that the printer is not out of paper or out of ink. Printing automatically restarts when the error is cleared. If the message still appears after checking, press MENU/OK to restart printing.
<b>[CANNOT BE PRINTED]</b>	Displayed for PictBridge.	<ul style="list-style-type: none"> <li>• Refer to the user manual for the printer being used and check whether the printer supports the JFIF-JPEG or Exif-JPEG image format. If not, the printer cannot print the images.</li> <li>• Movies cannot be printed.</li> <li>• Was the image data photographed using FinePix S8100fd? You may not be able to print some images photographed on other cameras.</li> </ul>

# Troubleshooting

## ■ Getting ready

Matters	Problems	Possible causes	Solutions	Page
Batteries and power supply	Nothing happens when sliding the ON/OFF switch or pressing  .	The batteries have run out.	Load new or fully charged batteries.	15, 16
		The batteries are loaded backward.	Load the batteries in the corrected direction.	16
		The batteries cover or slot cover is not closed securely.	Close the batteries cover or slot cover securely.	16
		The camera and AC power adapter are not connected correctly.	Connect the camera and AC power adapter correctly.	121
		The camera has been left for a long period with batteries and AC power adapter removed.	Load the batteries or connect the AC power adapter, and wait a short time before turning the camera on.	15, 21, 121
	Batteries run out quickly.	Camera is used in extremely cold conditions.	Put the batteries in your pocket or another warm place to heat it and then load it into the camera just before you take a picture.	15, 17
		The battery terminals are soiled.	Wipe the battery terminals with a clean, dry cloth.	17
		Same batteries have been used for a long period.	The batteries can no longer be recharged. Load a new batteries.	15, 17
	Power cuts out during operation.	The rechargeable batteries (if used) have become deactivated, or the battery capacity has diminished due to the memory effect.	Use the rechargeable battery discharging function to restore the rechargeable batteries to full capacity.	138
		The batteries have run out.	Load new or fully charged batteries.	15, 17
The camera and AC power adapter are not connected correctly.		Connect the camera and AC power adapter correctly.	121	







## ■ Setting menu etc.

Matters	Problems	Possible causes	Solutions	Page
LCD monitor display	Screens are not displayed in English.	A language other than English is selected in the [言語/LANG.] setting in the [SET-UP] menu.	Select [ENGLISH].	25

## ■ Shooting

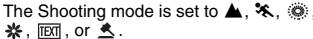
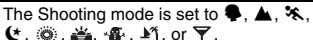
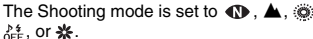
Matters	Problems	Possible causes	Solutions	Page
Basic operations	No photograph is taken when pressing the shutter button.	The Memory Card or internal memory is full.	Insert a new Memory Card or erase some unnecessary frames.	18, 42
		The Memory Card or internal memory is not formatted.	Format the Memory Card or internal memory on the camera.	111, 117
		The Memory Card contact area is soiled.	Wipe the Memory Card contact area with a soft, dry cloth.	18, 139
		The Memory Card is damaged.	Insert a new Memory Card.	18
		The batteries have run out.	Load new or fully charged batteries.	15, 16
	The Auto power off function has turned the camera off.	Turn the camera on.	21	
	The screen darkens after taking a picture.	You took pictures with flash.	The screen may darken for charging flash. Wait a short time.	66
Focusing	Camera has difficulty in focusing on the subject.	You took a close-up shot without selecting Macro mode.	Select Macro mode.	65
		You photographed scenery with Macro mode selected.	Cancel Macro mode.	65
		You are shooting a subject that is not suited to autofocus (→p.34).	Use AF/AE lock or "MF" Manual focus mode to take the picture.	33, 84

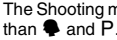
**Continued** ➔

Matters	Problems	Possible causes	Solutions	Page
Intelligent Face Detection	Cannot set Intelligent Face Detection.	The Shooting mode is set to  .	Change the Shooting mode.	49
Macro	Cannot set the camera to Macro (close-up) mode.	The Shooting mode is set to  .	Change the Shooting mode.	49
Flash	Cannot use the flash.	The shutter button was pressed while the flash was charging.	Wait until the charging is completed before pressing the shutter button.	66
		The flash is not popped up.	Pop up the flash.	66
		The Shooting mode is set to  .	Change the Shooting mode.	49
		The batteries have run out.	Load new or fully charged batteries.	15, 16
		Continuous shooting is selected.	Set continuous shooting to OFF.	68
		 Super macro mode is selected.	Cancel  Super macro mode.	65
	The flash settings are restricted and cannot be selected.	The Shooting mode is set to anything other than  and P.	The flash settings are restricted because the camera settings are tailored to the scene being shot. Change the Shooting mode for a wider range of flash settings.	49, 67
	The playback image is dark even though the flash was used.	The subject is too far away. Your finger was covering the flash.	Move to within the effective flash range before taking the picture. Hold the camera correctly.	66, 152 27
Photographed images	The image is blurred.	The lens is dirty.	Clean the lens.	137
		AF frame (lit red) and <b>!AF</b> appeared when taking pictures.	Check the focus on the subject and take pictures.	27, 32, 140
		 appeared when taking pictures.	It may cause camera shake. Hold the camera steadily.	28, 140
	There is speckling on the image.	The picture was taken with a slow shutter speed (long exposure) in a high-temperature environment.	This is a characteristic of CCDs and does not indicate a camera fault.	—

Matters	Problems	Possible causes	Solutions	Page
Recording images	Photographed images or movies are not recorded.	AC power adapter was connected or disconnected during turning the camera on.	Connect or disconnect the AC power adapter only when the camera is off. Failing to turn the camera off first can result in damage to the Memory Card or malfunctions during PC connection.	121
Continuous shooting	Only 1 frame can be shot even though continuous shooting mode was set.	A picture is taken using self-timer when setting [LONG PERIOD] continuous shooting mode.	Only 1 frame can be shot when using [LONG PERIOD] continuous shooting mode and Self-timer mode together.	68, 70
Sound	No sound from the camera.	Silent mode is set.	Release Silent mode.	110

**Continued** ➔

■ **Playing back**

Matters	Problems	Possible causes	Solutions	Page
Playing back movie / voice memo	The camera does not emit any sound.	The camera volume is set too low.	Adjust the volume.	102, 109, 111, 116
		The microphone was blocked during shooting/recording.	Take care not to block the microphone during shooting/recording.	11, 100, 106
		There is something covering the speaker during playback.	Make sure that the speaker is uncovered.	11, 101, 109
Erasing	Erasing [FRAME] does not erase the frame.	Some frames may be protected.	Unprotect frames using the camera on which the protection was first applied.	97
	Erasing [ALL FRAMES] does not erase all the frames.			
Frame No.	[CONTINUOUS] in the frame number setting does not function.	You opened the battery cover without turning the camera off when replacing the batteries or Memory Card.	Always turn the camera off when replacing the batteries or Memory Card. Opening the battery cover without turning the camera off may cause the frame number memory to not function.	21

## ■ Connecting

Matters	Problems	Possible causes	Solutions	Page
Connecting to TV	There is no image or sound on the TV.	The camera is not connected to the TV correctly.	Connect the camera and TV correctly.	120
		The included A/V cable was connected during movie playback.	After the movie playback mode is stopped, connect the camera and TV correctly.	108, 120
		"TV" is selected as the TV input.	Set the TV input to "VIDEO".	–
		The video output setting is incorrect.	Change the setting to [NTSC] or [PAL].	111, 113
	The TV volume is turned down.	Adjust the volume.	–	
	The TV image is black and white.	The video output setting is incorrect.	Change the setting to [NTSC] or [PAL].	111, 113
Connecting to PC	PC does not recognize the camera.	The USB cable is not correctly connected to the PC or camera.	Set up the camera, and connect the USB cable correctly.	131
Connecting to printer	Cannot print with PictBridge.	<ul style="list-style-type: none"> <li>The USB cable is not correctly connected to the printer or camera.</li> <li>The printer is not turned on.</li> </ul>	<ul style="list-style-type: none"> <li>Set up the camera, and connect the USB cable correctly.</li> <li>Turn the printer on.</li> </ul>	122

## ■ Others

Matters	Problems	Possible causes	Solutions	Page
Camera operation etc.	Nothing happens when pressing the buttons on the camera.	Camera malfunction may be caused temporarily.	Briefly remove the batteries or disconnect the AC power adapter. Then reload the batteries or reconnect the AC power adapter and try again.	15, 121
		The batteries have run out.	Load new or fully charged batteries.	15, 16
	The camera no longer works correctly.	Camera malfunction may be caused temporarily.	Briefly remove the batteries or disconnect the AC power adapter. Then reload the batteries or reconnect the AC power adapter and try again. If you think the camera is faulty, contact your FUJIFILM dealer.	15, 121

# Specifications

System	
<b>Model</b>	Digital camera FinePix S8100fd
<b>Effective pixels</b>	10.0 million pixels
<b>CCD</b>	1/2.3-inch CCD
<b>Storage media</b>	Internal memory (approx. 58 MB)/ <b>xD-Picture Card</b> (16/32/64/128/256/512 MB/1 GB/2 GB)/SD/SDHC Memory Card (FUJIFILM recommendation (→p.18))
<b>File format</b>	Still image: DCF-compliant Compressed: Exif ver.2.2 JPEG, DPOF-compatible *Design rule for Camera File System compliant/DPOF compatible Movie: AVI format, Motion JPEG Audio: WAVE format, Monaural sound
<b>Number of recorded pixels</b>	Still image: 3648 × 2736 pixels/3648 × 2432 pixels/2592 × 1944 pixels/2048 × 1536 pixels/ 1600 × 1200 pixels/640 × 480 pixels ( <b>10M</b> / <b>8.2M</b> / <b>6M</b> / <b>8M</b> / <b>2M</b> / <b>8M</b> )
<b>File size</b>	See the table on the p.154
<b>Lens</b>	Fujinon 18× optical zoom lens F2.8 (Wide-angle)-F4.5 (Telephoto)
<b>Focal length</b>	f=4.7 mm-84.2 mm (Equivalent to approx. 27 mm-486 mm on a 35 mm camera) Optical zoom focal length (when [MOVIE] is set) (35 mm camera equivalent): approx. 27 mm-486 mm (when [DUAL IS MODE] is set to off.) approx. 32 mm-810 mm (when [DUAL IS MODE] is set to on.)
<b>Digital zoom</b>	Approx. 5.7× (18× optical zoom lens is used together: Max. zoom scale: approx. 102.6×)
<b>Aperture</b>	F2.8-F8.0 (Wide-angle) / F4.5-F8.0 (Telephoto) in 1/3 EV increments Manual/Auto selectable
<b>Focal range (from lens surface)</b>	Normal: Wide-angle: approx. 70 cm (2.3 ft.) to infinity (In High-speed shooting mode: approx. 1 m (3.3 ft.) to infinity) Telephoto: approx. 1.5 m (4.9 ft.) to infinity (In High-speed shooting mode: approx. 1.5 m (4.9 ft.) to infinity) Macro: Wide-angle: 10 cm to 1.0 m (3.9 in. to 3.3 ft.) Telephoto: 1.2 m to 3.5 m (3.9 ft. to 11.5 ft.) Super macro: Approx. 1 cm to 0.1 m (0.4 in. to 0.3 ft.) Focal length: fixed to approx. 60 mm (35 mm camera equivalent) Movie: Wide-angle: 10 cm to infinity (3.9 in. to infinity) Telephoto: 1.2 m to infinity (3.9 ft. to infinity)

System	
<b>Sensitivity</b>	AUTO/AUTO(400)/AUTO(800)/AUTO(1600)/Equivalent to ISO 64/100/200/400/800/1600/3200 (max.number of recorded pixels: <b>5M</b> )/6400 (max.number of recorded pixels: <b>5M</b> ) (Standard output sensitivity)
<b>Photometry</b>	TTL 256-zones metering Multi, Spot, Average
<b>Exposure control</b>	Program AE (When using P mode : Program Shift is enabled)/Shutter priority AE/Aperture priority AE/Manual exposure
<b>Scene position</b>	((NATURAL LIGHT)),  ((NATURAL & )),  ((ZOOM BRACKETING)),  ((PORTRAIT)),  ((LANDSCAPE)),  ((SPORT)),  ((NIGHT)),  ((FIREWORKS)),  ((SUNSET)),  ((SNOW)),  ((BEACH)),  ((MUSEUM)),  ((PARTY)),  ((FLOWER)),  ((TEXT)),  ((AUCTION MODE))
<b>Picture Stabilization</b>	Available
<b>Intelligent Face Detection</b>	Available
<b>Exposure compensation</b>	-2 EV to +2 EV in 1/3 EV-step increments (A, S, P, )
<b>Shutter speed</b>	<b>AUTO</b> ,  ,  ,  ,  ,  ,  ,  ,  ,  ,  ,  ,  ,  ,  ,  : 1/4 sec. to 1/2000 sec.* : 3 sec. to 1/1000 sec.* : 4 sec. to 1/2 sec.* : 1/45 sec. to 1/2000 sec.* (flash only). M, S: 4 sec. to 1/2000 sec.* A, P: 1/45 sec. to 1/2000 sec.* (4 sec. to 1/2000 sec.* when suppressed flash is set) *depend on Exposure mode
<b>Continuous shooting</b>	Continuous shooting (TOP 3): Number of recorded frames: up to 3 frames (Max. 1.1 frames/sec.) Long period continuous shooting (LONG PERIOD): Number of recorded frames: Depend on memory size. (Max. 0.5 frames/sec.) High speed continuous shooting (TOP 33 <b>5M</b> ): Number of recorded frames: up to 33 frames (Max. 7 frames/sec.) (max. number of recorded pixels: 5.0 million) Ultra high speed continuous shooting (TOP 33 <b>8M</b> ): Number of recorded frames: up to 33 frames (Max. 13.5 frames/sec.) (max. number of recorded pixels: 3.0 million)
<b>Auto bracketing</b>	± 1/3 EV, ± 2/3 EV, ± 1 EV
<b>Focus</b>	Mode: Single AF, Continuous AF, Manual focus AF system: TTL contrast-type, AF-assist illuminator (effective distance: approx 1.8 m (5.9 ft.)) AF frame selection: AF (CENTER), AF (MULTI), AF (AREA)

## Specifications

System	
<b>White balance</b>	Automatic scene recognition/Preset (Fine, Shade, Fluorescent (Daylight), Fluorescent (Warm White), Fluorescent (Cool White), Incandescent) /Custom
<b>Self-timer</b>	Approx. 2 sec./10 sec.
<b>Flash type</b>	Auto flash Effective range: (☞): AUTO): approx. 50 cm-8.8 m (1.6 ft.-28.9 ft.) (Wide-angle) approx. 50 cm-5.6 m (1.6 ft. -18.4 ft.) (Telephoto) (Macro): approx. 30 cm-3.0 m (1.0 ft.-9.8 ft.) (Wide-angle) approx. 30 cm-3.0 m (1.0 ft.-9.8 ft.) (Telephoto)
<b>Flash mode</b>	Red-eye removal set to OFF: Auto, Forced Flash, Suppressed Flash, Slow Synchro Red-eye removal set to ON: Red-eye Reduction Auto, Red-eye Reduction & Forced Flash, Suppressed Flash, Red-eye Reduction & Slow Synchro
<b>Viewfinder</b>	0.24 inches, approx. 230,000 dots low-temperature polysilicon TFT color LCD finder, Approx. 97% coverage
<b>LCD monitor</b>	2.5 inches, Aspect ratio: 4:3; approx. 230,000 dots low-temperature polysilicon TFT color LCD monitor, Approx. 97% coverage
<b>Movie</b>	640 × 480 pixels/320 × 240 pixels (640/820) (30 frames per second with monaural sound)
<b>Photography functions</b>	Instant Zoom, Zoom Bracketing, Intelligent face detection, Red eye removal, High-speed shooting, Best framing, Post shot assist window, Frame No. memory, Histograms
<b>Playback functions</b>	Intelligent face detection, Micro thumbnails playback, Trimming, Slide Show, Multi-frame playback, Sorting by date, Image rotate, Histograms (Highlight warning), Voice memo
<b>Other functions</b>	PictBridge, Exif print, Language (日本語, English, Français, Deutsch, Español, Italiano, 中文簡, 繁體, 한글, Русский, Português, Nederlands, Türkçe, Český, Magyar, Polski, Svenska), Time difference, FinePix photo mode(F-mode), Discharging rechargeable batteries
Input/Output Terminal	
<b>A/V OUT (Audio/Visual output)</b>	NTSC/PAL-type (with monaural sound)
<b>Digital input/output</b>	USB
<b>DC input socket</b>	AC Power Adapter AC-5VX (sold separately)



## Power Supply and Others

### Power supply

Use one of the following:

- 4x AA-size alkaline batteries
- 4x AA-size Ni-MH (Nickel-Metal Hydride) batteries (sold separately)
- AC Power Adapter AC-5VX (sold separately)

### Guide to the number of available frames for battery operation

Battery Type	With LCD monitor ON	With viewfinder (EVF) ON
Alkaline batteries	Approx. 350 frames	Approx. 350 frames
Ni-MH batteries 2500 mAh	Approx. 500 frames	Approx. 500 frames

According to the CIPA (Camera & Imaging Products Association) standard procedure for measuring digital still camera battery consumption (extract):

When using alkaline batteries, use the batteries supplied with the camera. You can use Ni-MH batteries also. The storage media should be **xD-Picture Card**.

Pictures should be taken at a temperature of +23°C (+73°F), with the LCD monitor turned on, the optical zoom moved from full wide-angle to full telephoto (or vice-versa) and back again to its original position every 30 seconds, the flash used at full power every second shot and the camera turned off and then on again once every 10 shots.

- Note: Because the number of available shots varies depending on the capacity of alkaline batteries or the level of charge in Ni-MH batteries, the figures shown here for the number of available shots using batteries are not guaranteed.

The number of available shots will also decline at low temperatures.

**Camera dimensions (W/H/D)** 111.3 mm × 78.2 mm × 79.3 mm/4.4 in. × 3.1 in. × 3.1 in. (not including accessories and attachments)

**Camera mass (weight)** Approx. 405 g/14.3 oz. (not including accessories, batteries and Memory Card)

**Weight for photography** Approx. 500 g/17.6 oz. (including batteries and Memory Card)

**Operating Conditions** Temperature: 0°C to +40°C (+32°F to +104°F)  
80% humidity or less (no condensation)

**Continued** ➔

**■ Standard number of available frames/recording time per xD-Picture Card, SD Memory Card and internal memory**

The number of available frames and recording time is approximate. Actual number of frames and recording time varies depending on the types of Memory Card or shooting condition. Also, the number of frames and recording time displayed in the LCD monitor may not decrease regularly.

Quality setting	10M F	10M N	3:2	5M	3M	2M	03M	640 (30 fps)	320 (30 fps)	
Number of recorded pixels	3648×2736		3648×2432	2592×1944	2048×1536	1600×1200	640×480	640×480	320×240	
Image data size	4.9 MB	2.5 MB	2.2 MB	1.3 MB	810 KB	640 KB	150 KB	–	–	
Internal memory (approx. 58 MB)	11	23	25	44	70	87	358	62 sec.	99 sec.	
xD-Picture Card	16 MB	3	6	7	12	19	24	99	17 sec.	27 sec.
	32 MB	6	12	14	24	39	48	199	34 sec.	55 sec.
	64 MB	12	25	28	49	78	97	399	1.2 min.	1.8 min.
	128 MB	25	51	57	99	156	194	799	2.3 min.	3.7 min.
	256 MB	51	103	115	199	313	390	1599	4.7 min.	7.4 min.
	512 MB	103	206	231	399	626	779	3196	9.3 min.	14.8 min.
	1 GB	207	412	463	799	1254	1560	6397	18.7 min.	29.6 min.
	2 GB	415	820	927	1599	2460	3046	12796	36.8 min.	59.2 min.
SD Memory Card	512 MB	100	199	224	386	606	754	3095	9.0 min.	14.3 min.
	1 GB	201	399	449	774	1215	1511	6197	18.1 min.	28.7 min.
	2 GB	402	795	898	1550	2385	2953	12403	35.6 min.	57.4 min.
SDHC Memory Card	4 GB	805	1591	1798	3102	4773	5909	24821	71.3 min.*	114.9 min.*
	8 GB	1617	3192	3609	6225	9578	11858	49807	143.1 min.*	230.5 min.*

\* A movie recording will stop automatically when a movie file becomes approx. 2GB. If you want to continue recording another movie, press the shutter button again. The available recording time is displayed based on approx. 2GB.

---

If you shoot using the **xD-Picture Cards** with model numbers containing "M" such as DPC-M1GB, movie recording time may be reduced if you repeatedly record and erase (frame erase) image files. In such a case, erase all frames or format the **xD-Picture Card** before use. Back up important frames (files) onto your PC or another media.

- \* These specifications are subject to change without notice. FUJIFILM shall not be held liable for damages resulting from errors in this Owner's Manual.
- \* The LCD monitor on your digital camera is manufactured using advanced high-precision technology. Even so, small bright points and anomalous colors (particularly around text) may appear on the monitor. These are normal display characteristics and do not indicate a fault with the monitor. This phenomenon will not appear on the recorded image.
- \* The operation error may be caused in a digital camera by the strong radio interference (i. e. electric fields, static electricity, line noise, etc.).
- \* Due to the nature of the lens, the edges of images may appear distorted. This is normal.

# Explanation of Terms

---

## **Deactivated batteries**

Leaving an Ni-MH battery unused in storage for a long period may cause a rise in the level of substances that inhibit current flow inside the battery and result in a dormant battery. A battery in this state is referred to as deactivated.

Because current flow is inhibited in a deactivated Ni-MH battery, the battery's original level of performance cannot be achieved.

## **EV**

A number denotes Exposure Value. The EV is determined by the brightness of the subject and sensitivity (speed) of the film or CCD. The number is larger for bright subjects and smaller for dark subjects. As the brightness of the subject changes, a digital camera maintains the amount of light hitting the CCD at a constant level by adjusting the aperture and shutter speed. When the amount of light striking the CCD doubles, the EV increases by 1. Likewise, when the light is halved, the EV decreases by 1.

## **Frame rate (fps)**

The frame rate refers to the number of images (frames) that are photographed or played back per second. For example, when 10 frames are continuously photographed in a 1-second interval, the frame rate is expressed as 10 fps.

For reference, TV images are displayed at 30 fps (NTSC).

## **JPEG**

Joint Photographic Experts Group

A file format used for compressing and saving color images. The higher the compression rate, the greater the loss of quality in the decompressed (restored) image.

## **Memory effect**

If an Ni-MH battery is repeatedly charged without first being fully discharged, its performance may drop below its original level. This is referred to as the "memory effect".

## **Motion JPEG**

A type of AVI (Audio Video Interleave) file format that handles images and sound as a single file. Images in the file are recorded in JPEG format. Motion JPEG can be played back by QuickTime 3.0 or later.

## **Smear**

A phenomenon specific to CCDs whereby white streaks appear on the image when there is a very strong light source, such as the sun or reflected sunlight, in the photography screen.

## **WAVE**

A standard format used on Windows systems for saving audio data. WAVE files have the ".WAV" file extension and the data can be saved in either compressed or uncompressed format. Uncompressed recording is used on this camera.

WAVE files can be played back on a personal computer using the following software:

Windows: MediaPlayer

Macintosh: QuickTime Player

\* QuickTime 3.0 or later

---

**White Balance**

Whatever the kind of the light, the human eye adapts to it so that a white object still looks white. On the other hand, devices such as digital cameras see a white subject as white by first adjusting the color balance to suit the color of the ambient light around the subject. This adjustment is called matching the white balance.



Exif Print Format is a newly revised digital camera file format that contains a variety of shooting information for optimal printing.

# FUJIFILM Digital Camera Worldwide Network

If you have technical questions or if you need repair service, ask the following local distributor. Please present the warranty card and your purchase receipt when you ask for repairs. Refer to the warranty card for conditions of the warranty. There is a case that repair and Technical support cannot be accepted for some models which your local distributor does not deal with. These lists are subject to change without notice.

<b>NORTH AMERICA</b>		
Canada	<b>FUJIFILM Canada Inc.</b>	600 Suffolk Court Mississauga Ontario, L5R 4G4
	Technical support	TEL 1-866-818-FUJI (3854) <a href="http://www.fujihelp.ca">http://www.fujihelp.ca</a>
U.S.A.	<b>FUJIFILM U.S.A., Inc.</b>	600 Suffolk Court Mississauga Ontario, L5R 4G4
	Technical support	TEL 1-800-263-5018 FAX 1-905-755-2993 <a href="http://www.fujihelp.ca">http://www.fujihelp.ca</a>
Hawaii	<b>FUJIFILM U.S.A., Inc.</b>	1100 King George Post Rd., Edison, NJ 08837
	Technical support	TEL 800-800-3854 FAX 732-857-3487 <a href="mailto:digitalinfo@fujifilm.com">digitalinfo@fujifilm.com</a>
Hawaii	<b>FUJIFILM U.S.A., Inc.</b>	1100 King George Post Rd., Edison, NJ 08837
	Repair service	TEL 732-857-3000 FAX 732-857-3471 <a href="mailto:njcamerarepair@fujifilm.com">njcamerarepair@fujifilm.com</a>
Hawaii	<b>FUJIFILM Hawaii, Inc.</b>	94-468 Akoki Street, Waipahu, HI. 96797
	Technical support & Repair service	TEL 1-808-677-3854, ext. 209 FAX 1-808-677-1443 <a href="mailto:kurt_kmett@fujifilmhawaii.com">kurt_kmett@fujifilmhawaii.com</a>
<b>CENTRAL &amp; SOUTH AMERICA</b>		
Argentina	<b>Imagen e informacion S.A.</b>	Fondo de la Legua 936 San Isidro Pcia. de Buenos Aires
	Technical support & Repair service	TEL +54-11-4836-1000 FAX +54-11-4836-1144 <a href="http://servtec@imageneinformacion.com.ar">servtec@imageneinformacion.com.ar</a>
Bolivia	<b>Reifschneider Bolivia Ltda.</b>	Calle H N.º 5 - Equipetrol Norte - Santa Cruz
	Technical support & Repair service	TEL +591 33 44 1129 FAX +591 33 45 2919 <a href="mailto:gciagral@bibosi.scz.entelnet.bo">gciagral@bibosi.scz.entelnet.bo</a>
Brazil	<b>FUJIFILM do Brasil Ltda.</b>	Av. Vereador José Diniz, 3400 - Campo Belo, São Paulo/SP
	Technical support & Repair service	TEL 0800-12-8600 FAX +55 11 5091-4150 <a href="http://camarasdigitais@fujifilm.com.br">camarasdigitais@fujifilm.com.br</a>
Chile	<b>Reifschneider SA</b>	Av. El Conquistador del Monte 5024, Huechuraba, Santiago, Chile
	Technical support & Repair service	TEL 02-4431500 FAX 02-4431596 <a href="mailto:ceciliacalvo@reifschneider.cl">ceciliacalvo@reifschneider.cl</a>
Colombia	<b>Animex de Colombia Ltda.</b>	Calle 44 N.º 13-43 Piso 2 Apartado 18001 - Bogotá
	Technical support & Repair service	TEL +57 1 338-0299 FAX +57 1 288-2208 <a href="http://animex@etb.net.co">animex@etb.net.co</a>
Ecuador	<b>Espacri Cia Ltda</b>	Bolivar 5-69 y Hermano Miguel
	Technical support & Repair service	TEL 593-72-835526 FAX 593-72-833157
Ecuador	<b>Importaciones Espacri Cia. Ltda.</b>	Simón Bolívar 5-69 y Hno. Miguel - Cuenca
	Technical support & Repair service	TEL +593 783 5526 FAX +593 783 3157 <a href="mailto:portiz@fujifilm.com.ec">portiz@fujifilm.com.ec</a>
Mexico	<b>Fujifilm de Mexico, S.A. de C.V.</b>	Av. Ejercito Nacional 351, Col. Granada 11520 Mexico, D.F.
	Technical support	TEL (52-55) 5263-5566 / 68 FAX (52-55) 5254-1508 <a href="mailto:jlgraud1@fujifilm.com.mx">jlgraud1@fujifilm.com.mx</a>
Mexico	<b>Fujifilm de Mexico, S.A. de C.V.</b>	Av. Presidente Juarez 2007, Col. Tepetlaco, 54090 Tlalnepantla, Edo. de Mexico
	Repair service	TEL (52-55) 5263-5500 FAX (52-55) 5254-1508 <a href="mailto:jlgraud1@fujifilm.com.mx">jlgraud1@fujifilm.com.mx</a>

Paraguay	<b>Errece S.R.L.</b> Technical support & Repair service	Edificio Unitas 15 de Agosto 1035, Asunción TEL +595 21 444256 FAX +595 21 444651 jmarbulo@fujifilm.com.py
Peru	<b>Procesos de Color S.A.</b> Technical support & Repair service	Pablo Bermudez 111 Apartado 3794 - Esq. Arequipa - Lima 11 TEL +51 14 33 5563 FAX +51 14 33 7177 jalvarado@fujifilm.com.pe
Uruguay	<b>Fotocamara S.R.L.</b> Technical support & Repair service	Cuareim 1439, monteideo, Uruguay TEL +598-2-9002004 FAX +598-2-9008430 fotocam@adinet.com.uy
Uruguay	<b>Kiel S.A.</b> Technical support & Repair service	Maldonado 1787 Montevideo- Uruguay TEL (05982) 419 4542 FAX (05982) 412 0046 kiel@fujifilm.com.uy
Venezuela	<b>C. Hellmund &amp; Cia Sa</b> Technical support & Repair service	Av. Ppal Diego Cisneros Caracas Venezuela Edf Oficentro TEL 0212-2022300 FAX 0212-2399796 hellmund@hellmund.com

## EUROPE

Austria	<b>Fuji Film Oesterreich</b> Technical support & Repair service	Traviatagasse/Pfarrgasse, 1230 Vienna, Austria TEL 0043 1 6162606/51 or 52 FAX 0043 1 6162606/58 kamera.service@fujifilm.at
Belgium	<b>Belgian Fuji Agency</b> Technical support & Repair service	20, Avenue Lavoisier, Wavre, 1300, Belgium TEL 3210242090 FAX 3210238562 info@fuji.be
Croatia	<b>I&amp;I d.o.o.</b> Technical support Repair service	Hondlova 2, Zagreb, Croatia TEL 38512319060 FAX 2310240 dsaravanja@fujifilm.hr Hondlova 2, Zagreb, Croatia TEL 38512316228 FAX 2310240 info@fujifilm.hr
Cyprus	<b>PMS IMAGING LTD</b> Technical support & Repair service	11, Dighenis Akritas Avenue, P.O.BOX 22315, 1586 Nicosia TEL 35722746746 FAX 35722438209 mariosashiotis@fujifilm.com.cy
Cyprus	<b>Doros Neophytou CAMERA REPAIRS</b> Technical support & Repair service	28B, Agiou Demetriou, Acropoli, Nicosia TEL 35722314719 FAX 35722515562 dorosn@logosnet.cy.net
Czech Republic	<b>Fujifilm Cz., s.r.o.</b> Technical support	U nakladoveho nadrazi 2/1949, 130 00 Praha 3 TEL 00420 234 703 411 FAX 00420 234 703 489 fricman@fujifilm.cz
Czech Republic	<b>AWH servis</b> Repair service	Milesovska 1, 130 00 Praha 3, Czech republic TEL 00420 222 721 525 FAX 00420 222 720 122 awh@awh.cz
Denmark	<b>Fujifilm Danmark A/S</b> Technical support & Repair service	Stubbeled 2, 2950 Vedbæk Denmark TEL 0045 45662244 FAX 0045 45662214 fujifilm@fujifilm.dk
Finland	<b>Fuji Finland Oy</b> Technical support & Repair service	Martinkyläntie 41, 01720 Vantaa, Finland TEL +358 9 825951 FAX +358 9 870 3818 fuji@fuji.fi
France	<b>FUJIFILM France</b> Technical support & Repair service	2, Avenue Franklin, 78186 Saint-Quentin en Yvelines, France FAX 33 1 01 30 58 58 65 direction.technique@fujifilm.fr

## FUJIFILM Digital Camera Worldwide Network

Germany	<b>FUJIFILM Electronic Imaging Europe GmbH</b> Technical support & Repair service	Benzstrasse 2, 47533 Kleve, Germany International call TEL +49 211 50890 FAX +49 211 5089668 service@fujifilm.de National call* TEL 0180 5898980 FAX 0180 5898982 *12 Cent/Min aus dem deutschen Festnetz
Greece	<b>FUJIFILM HELLAS S.A.</b> Technical support & Repair service	1, Ihouc & Ag. Anargiron str., 175 64 P.Phaliro, Athens, Greece TEL 0030 210 9404100 FAX 0030 210 9404397 fujifilm@fujifilm.gr
Hungary	<b>Fujifilm Hungary Ltd.</b> Technical support	Vaci ut 19. Budapest, 1134, Hungary TEL 3612389410 FAX 3612389401 fujifilm@fujifilm.hu
Iceland	<b>Icephoto (Ljosmyndavorur)</b> Technical support & Repair service	Skipholt 31, 105 Reykjavik, Iceland TEL 354 568 0450 FAX 354 568 0455 framkollun@fujifilm.is
Italy	<b>FujiFilm Italia S.p.A.</b> Technical support Repair service	Via Dell'Unione Europea, 4 - 20097 San Donato Milanese (MI), Italy TEL 039-02895821 FAX 039-0289582912 info@fujifilm.it Fujifilm On Line - Call center TEL 039-026695272 info@fujifilm.it
Lithuania	<b>Fujifilm Lithuania</b> Technical support & Repair service	Gerosios Vilties str. 38, LT-03143 Vilnius, Lithuania TEL 370-5-2130121 FAX 3705-5-2134066 info@fujifilm.lt
Malta	<b>Ciancio (1913) Co.Ltd.</b> Technical support & Repair service	Fuji Tech Centre, Ciancio House, Cannon Road, Qormi, QRM05 TEL 0356-21-480500 FAX 0356-21-488328 info@fujifilm.com.mt
Norway	<b>Fujifilm Norge AS</b> Technical support Repair service	Lilleakerveien 10, 0283 Oslo, Norway TEL 0047-02273 FAX 0047-22736020 http://www.fujifilm.no/ mailto:post@fujifilm.no Liaveien 1, 5132 Nyborg, Norway TEL 0047-55393880 FAX 0047-55195201 http://www.camera.no/ mailto:service@camera.no
Poland	<b>Fujifilm Polska Distribution Sp. z o.o.</b> Technical support Repair service	Poland Al...Jerozolimskie 178; 02-486 Warszawa TEL +48-22-517-66-00 FAX +48-22-517-66-02 fujifilm@fujifilm.pl Poland, Muszkieterow 15, 02-273 Warszawa TEL +48-22-886-94-40 FAX +48-22-886-94-42 serwis@fujifilm.pl
Portugal	<b>Fujifilm Portugal, Lda</b> Technical support Repair service	Av. Fontes Pereira de Melo, 342, 4100-259 Porto, Portugal TEL (351) 226194200 FAX (351) 226194213 finepix@fujifilm.pt Av. Fontes Pereira de Melo, 342, 4100-259 Porto, Portugal TEL (351) 226194200 FAX (351) 225194662 cameras@fujifilm.pt
Romania	<b>CTS-Cardinal Top Systems Ltd</b> Technical support & Repair service	112, Calea Dorobanti street, 4 flat, 1sector, Bucharest, Romania TEL 4021-230-09-82 FAX 4021-230-09-82 cts_tirla@hotmail.com



Russia	<b>ZAO "Fujifilm RU"</b> Technical support	Bld. 1, 10, Rozanova str., Moscow, 123007, Russia TEL +7-095-956-9858 FAX +7-095-230-6217 info@fujifilm.ru
	Repair service	18, Shelepikhinskaya Naberezhnaya str., Moscow, 123290, Russia TEL +7-095-797-3434 FAX +7-095-797-3434
Slovakia	<b>Fujifilm Slovakia</b> Technical support	Pribylinska 2, 831 04 Bratislava, Slovakia TEL 00421 2 44 888 077 FAX 00421 2 44 889 300 fujifilm@fujifilm.sk
	Repair service	FIS Tatracentrum, Hodzovo nam. 4 - Tatracentrum, 811 06 Bratislava, Slovakia TEL 00421 2 54 647 347 fis.tatracentrum@stonline.sk
Spain	<b>Fujifilm España S.A.</b> Technical support	Aragón 180, 08011 Barcelona (España) TEL 902012535 FAX 934515900 / 933230330 info@fujifilm.es
	Repair service	Aragón 180, 08011 Barcelona (España) TEL 934511515 FAX 934515900 / 933230330 tallersat@fujifilm.es
Sweden	<b>Fujifilm Sverige AB</b> Technical support	Sveavägen 167 104 35 Stockholm TEL 46 8 506 141 70 FAX 46 8 506 142 09 kamera@fujifilm.se
	Repair service	Sveavägen 167 104 35 Stockholm TEL 46 8 506 513 54 FAX 46 8 506 513 99 kameraverkstaden@fujifilm.se
Switzerland / Lichtenstein	<b>Fujifilm (Switzerland) AG</b> Technical support & Repair service	Niederhaslistrasse 12, 8157 Dietlikon, Switzerland TEL +41 44 855 5154 FAX +41 44 855 5329 RepairCenter@fujifilm.ch
The Netherlands	<b>FUJIFILM Electronic Imaging Nederland</b> Technical support	Hoogstraat 35, 3011 PE Rotterdam, Nederlands TEL +31(0)102812500 FAX +31(0)102812560 helpdesk@fujifilm-digital.nl
	Repair service	Hoogstraat 35, 3011 PE Rotterdam, Nederlands TEL +31(0)102812520 FAX +31(0)102812550 camerareparaties@fujifilm-digital.nl
Turkey	<b>Fujifilm Turkiye Sinfo A.S.</b> Technical support	Fujifilm Plaza, Dereboyu Cad. 39 34660 Halkali, Istanbul, Turkey TEL +90 212 696 5090 FAX +90 212 696 5009 csarp@fujifilm.com.tr
	Repair service	Fujifilm Plaza, Dereboyu Cad. 39 34660 Halkali, Istanbul, Turkey TEL +90 212 696 5090 FAX +90 212 696 5010 servis@fujifilm.com.tr
U.K.	<b>FUJIFILM UK Ltd.</b> Technical support	St Martins Way St Martins Business Centre Bedford MK42 0LF TEL +44 (0)123 424 5383 FAX +44 (0)123 424 5285 fujitec@fuji.co.uk
	Repair service	St Martins Way St Martins Business Centre Bedford MK42 0LF TEL +44 (0)123 421 8388 FAX +44 (0)123 424 5285 fujitec@fuji.co.uk
Ukraine	<b>Image Ukraine CJSC</b> Technical support & Repair service	12, Kontraktova ploshcha, Kyiv 04070, Ukraine TEL +380-44-4909075 FAX +380-44-4909076 d@fujifilm.ua

#### MIDDLE EAST

Iran	<b>Tehran Fuka Co.</b> Technical support & Repair service	229,"Fuji" Bldg., Mirdamad Blvd., Tehran 19189, Iran TEL (+98-21)2254810-19 FAX (+98-21)2221002 fuka@neda.net
------	--	--

## FUJIFILM Digital Camera Worldwide Network

Israel	<b>Shimone Group Ltd.</b>	Efal 33 keyriat Arie Petah Tikva 49130, Israel
	Technical support	TEL (+ ) 972 3 9250666 digital@fujifilm.co.il
	Repair service	Efal 33 keyriat Arie Petah Tikva 49130, Israel TEL (+ ) 972 3 9250666 FAX 972 3 9250699 khaim@shimone.com
Jordan	<b>Grand Stores</b>	Al- Abdali, Amman / Jordan
	Technical support & Repair service	TEL 009626-4646387 FAX 009626-4647542 gstores@go.com.jo
Qatar	<b>Techno Blue</b>	Blue Salon Bldg, 3rd Floor, Suhaim bin Hamad st, Al- Saad, Doha
	Technical support	TEL 00974 44 66 175 FAX 00974 44 79 053 prabu@techno-blue.com
Saudi Arabia	<b>Emam Distribution Co. Ltd.</b>	P.O. Box 1716, Jeddah 21441, Saudi Arabia
	Technical support	TEL 96626978756 FAX 96626917036 service@fujifilm.com.sa
Syria	<b>Film Trading Company</b>	Al-Shahbandar P.O. Box:31180 Damascus SYRIA
	Technical support	TEL + 963 11 2218049 FAX + 963 11 44673456 f.t.c@Net.SY
	Repair service	Al-cheikh Taha P.O. Box: 6171 Aleppo SYRIA TEL + 963 21 4641903 FAX + 963 21 4641907 filmtradin@Net.SY
U.A.E.	<b>Grand Stores</b>	P. O. Box 2144, Saleh Bin Lahej Building, Al Garhoud, Deira, Dubai
	Technical support & Repair service	TEL + 971-4-2823700 FAX + 971-4-2828382 photography@grandstores.ae
Yemen	<b>Al-Haidary Trading</b>	P.O.Box-2942 Haddah St. HTC, Sana'a, Yemen
	Technical support	TEL 00967-1-503980 FAX 00967-1-503983
	Repair service	P.O.Box-2942 Haddah St. HTC, Sana'a, Yemen TEL 00967-1-503977 FAX 00967-1-503983

### AFRICA

Egypt	<b>Foto Express Egypt</b>	426 Pyramids St., Giza, Egypt
	Technical support & Repair service	TEL (202) 7762062 FAX (202) 7760169 fotoegypt@access.com.eg
Kenya	<b>Fuji Kenya Ltd</b>	P.O.Box 41669-00100, Fuji Plaza, Chiromo Road, Nairobi, Kenya.
	Repair service	TEL (254-20)4446265-8 FAX (254-20)4448515 / 7 info@fujifilm.co.ke

### OCEANIA

Australia	<b>FUJIFILM Australia Pty Ltd</b>	Locked Bag 5100, Brookvale, NSW, 2100
	Technical support & Repair service	TEL 1800 226 355 FAX +61 (2) 9466 2854 digital@fujifilm.com.au
Fiji	<b>Brijjal &amp; Co. Ltd</b>	70-72 Cumming Street, Suva, Fiji
	Technical support & Repair service	TEL (679)3304133 FAX (679)3302777 kapadia@connect.com.fj
New Caledonia	<b>Phocidis SARL</b>	58, rue Higginson - B.P.661 - 98845
	Technical support & Repair service	TEL (00 687) 25-46-35 FAX (00 687) 28-66-70 phocidis@phocidis.nc
New Zealand	<b>Fujifilm NZ Ltd</b>	Cnr William Pickering & Bush Road Albany, Auckland
	Technical support & Repair service	TEL +64-9-4140400 FAX +64-9-4140410 glenn.beaumont@fujifilm.co.nz
Papua New Guinea	<b>Oceania PNG Limited</b>	Section 15, Allotment 1, Reke St, Boroko NCD. PNG. Mail: PO Box 2167, Boroko NCD. PNG. TEL +675 3256411 FAX +675 3250311 oceania@daltron.com.pg

<b>ASIA</b>		
Hong Kong	<b>Fuji Photo Products Co., Ltd.</b> Technical support & Repair service	8/F., TSUEN WAN IND. CENTRE, 220 TEXACO RD., TSUEN WAN, HONG KONG TEL (852)2406 3287 FAX (852)2408 3130 rsd@chinahkphoto.com.hk
Indonesia	<b>PT Modern Photo Tbk</b> Technical support & Repair service	Jl.Matraman Raya 12, Jakarta Timur 13150 TEL +62 021 2801000 FAX +62 021 8581620+62 021 2801012 assd_kmr@modernphoto.co.id
Malaysia	<b>FUJIFILM (Malaysia) Sdn. Bhd.</b> Technical support Repair service	Letter Box 1, Level 10, 11 & 12, Menara Axis, No 2, Jalan 51A/223, 46100 Petaling Jaya, Selangor Darul Ehsan, Malaysia TEL 603-79584700 FAX 603-79584110 digital@fujifilm.com.my Letter Box 1, Level 10, 11 & 12, Menara Axis, No 2, Jalan 51A/223, 46100 Petaling Jaya, Selangor Darul Ehsan, Malaysia TEL 603-79584700 FAX 603-79584110 technical@fujifilm.com.my
Philippines	<b>YKL Development &amp; Trdg. Corp.</b> Technical support Repair service	24 Sto. Domingo St., Quezon City 1100, Philippines TEL 632-7436601-06 FAX 632-7324661 digital@yklcolor.com 24 Sto. Domingo St., Quezon City 1100, Philippines TEL 632-7436601-06 FAX 632-7324661 tech_services@yklcolor.com
Singapore	<b>FUJIFILM (Singapore) Pte Ltd</b> Technical support & Repair service	10 New Industrial Road Fujifilm Building Singapore 536201 TEL 65-6380 5557 FAX 65-6281 3594 service@fujifilm.com.sg
South Korea	<b>Korea Fujifilm Co., Ltd.</b> Technical support	30-1, Mukjeung-dong, Jung-gu, Seoul, Korea TEL +82-2-3282-7363 FAX +82-2-2269-7435 photo@fujifilm.co.kr
South Korea	<b>Yonsan AS Center (Fujidigital)</b> Repair service	#301, 3F, Jeonjaland, 16-9, Hangangro3-ga, Yongsan-gu, Seoul, Korea TEL +82-2-701-1472 FAX +82-2-718-1331 1bowl@hanmail.net
South Korea	<b>Kangnam AS Center (Digitalgallery)</b> Repair service	2F, Hyeongin Tower, 23-2, Bangyi-dong, Songpa-gu, Seoul, Korea TEL +82-2-2203-1472 FAX +82-2-418-5572 nurjili@hanmail.net
South Korea	<b>Busan AS Center (Digital-Sewon)</b> Repair service	241-4, Bujeon-dong, Busanjin-gu, Busan, Korea TEL +82-51-806-1472 FAX +82-51-817-0083 merahan@yahoo.co.kr
Taiwan	<b>Hung Chong Corp.</b> Technical support & Repair service	No. 38, Min-Chuan E. Rd. Sec. 6, Taipei (114), Taiwan, R.O.C. TEL 886-2-6602-8988 FAX 886-2-2791-8647 dah@mail.hungchong.com.tw
Thailand	<b>FUJIFILM (Thailand) Ltd.</b> Technical support Repair service	388 SP Building, 8th Floor, Phayathai, Bangkok 10400 TEL +662-2730029 ext. 755 FAX +662-2730239 supaleark@fujifilm.co.th 388 SP Building, 8th Floor, Phayathai, Bangkok 10400 TEL +662-2730029 ext.761,762 FAX +662-2730239 warin@fujifilm.co.th
Vietnam	<b>International Minh Viet Co., Ltd.</b> Technical support & Repair service	99-107 Bach Van street, Ward 5, District 5, Ho chi minh city TEL +84-8-8366807 ext.122 FAX +84-8-8380621 diep.phanthithanh@imv.com.vn

# FUJIFILM

---

**FUJIFILM Corporation**

7-3, AKASAKA 9-CHOME, MINATO-KU, TOKYO 107-0052, JAPAN

[http://www.fujifilm.com/products/digital\\_cameras/index.html](http://www.fujifilm.com/products/digital_cameras/index.html)

Printed in China

# Notes and Cautions

## IMPORTANT SAFETY INSTRUCTIONS

### Read Instructions:

All the safety and operating instructions should be read before the appliance is operated.

### Retain Instructions:

The safety and operating instructions should be retained for future reference.

### Heed Warnings:

All warnings on the appliance and in the operating instructions should be adhered to.

### Follow Instructions:

All operating and use instructions should be followed.

### Installation

**Power Sources**—This video product should be operated only from the type of power source indicated on the marking label. If you are not sure of the type of power supply to your home, consult your appliance dealer or local power company. For video products intended to operate from battery power, or other sources, refer to the operating instructions.

**Grounding or Polarization**—This video product is equipped with a polarized alternating-current line plug (a plug having one blade wider than the other). This plug will fit into the power outlet only one way. This is a safety feature. If you are unable to insert the plug fully into the outlet, try reversing the plug. If the plug should still fail to fit, contact your electrician to replace your obsolete outlet. Do not defeat the safety purpose of the polarized plug.

**Alternate Warnings**—This video product is equipped with a 3-wire grounding-type plug, a plug having a third (grounding) pin. This plug will only fit into a grounding-type power outlet. This is a safety feature. If you are unable to insert the plug into the outlet, contact your electrician to replace your obsolete outlet. Do not defeat the safety purpose of the grounding-type plug.

**Overloading**—Do not overload wall outlets and extension cords as this can result in a risk of fire or electric shock.

**Ventilation**—Slots and openings in the cabinet are provided for ventilation and to ensure reliable operation of the video product and to protect it from overheating, and these openings must not be blocked or covered.

The openings should never be blocked by placing the video product on a bed, sofa, rug, or other similar surface.

This video product should not be placed in a built-in installation such as a bookcase or rack unless proper ventilation is provided or the manufacturer's instructions have been adhered to.

This video product should never be placed near or over a radiator or heat register.

**Attachments**—Do not use attachments not recommended by the video product manufacturer as they may cause hazards.

**Water and Moisture**—Do not use this video product near water – for example, near a bath tub, wash bowl, kitchen sink, or laundry tub, in a wet basement, or near a swimming pool, and the like.

**Power-Cord Protection**—Power-Supply cords should be routed so that they are not likely to be walked on or pinched by items placed upon or against them, paying particular attention to cords at plugs, convenience receptacles, and the point where they exit from the appliance.

**Accessories**—Do not place this video product on an unstable cart, stand, tripod, bracket, or table. The video product may fall, causing serious injury to a child or adult, and serious damage to the appliance. Use only with a cart, stand, tripod, bracket, or table recommended by the manufacturer, or sold with the video product. Any mounting of the appliance should follow the manufacturer's instructions, and should use a mounting accessory recommended by the manufacturer.

An appliance and cart combination should be moved with care. Quick stops, excessive force, and uneven surfaces may cause the appliance and cart combination to overturn.



### Antennas

**Outdoor Antenna Grounding**—If an outside antenna or cable system is connected to the video product, be sure the antenna or cable system is grounded so as to provide some protection against voltage surges and built-up static charges. Section 810 of the National Electrical Code, ANSI/NFPA No. 70, provides information with respect to proper grounding of the mast and supporting structure, grounding of the lead-in wire to an antennadischarge unit, size of grounding conductors, location of antenna-discharge unit, connection to grounding electrodes, and requirements for the grounding electrode.

**Power Lines**—An outside antenna system should not be located in the vicinity of overhead power lines or other electric light or power circuits, or where it can fall into such power lines or circuits. When installing an outside antenna system, extreme care should be taken to keep from touching such power lines or circuits as contact with them might be fatal.

EXAMPLE OF ANTENNA GROUNDING AS PER NATIONAL ELECTRICAL CODE

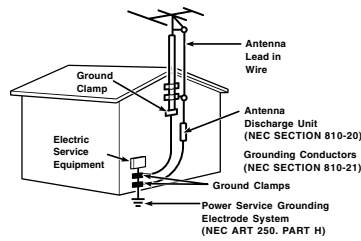

### Use

**Cleaning**—Unplug this video product from the wall outlet before cleaning. Do not use liquid cleaners or aerosol cleaners. Use a damp cloth for cleaning.

**Object and Liquid Entry**—Never push objects of any kind into this video product through openings as they may touch dangerous voltage points or shortout parts that could result in a fire or electric shock. Never spill liquid of any kind on the video product.

**Lightning**—For added protection for this video product receiver during a lightning storm, or when it is left unattended and unused for long periods of time, unplug it from the wall outlet and disconnect the antenna or cable system. This will prevent damage to the video product due to lightning and power-line surges.

### Service

**Servicing**—Do not attempt to service this video product yourself as opening or removing covers may expose you to dangerous voltage or other hazards. Refer all servicing to qualified service personnel.

**Damage Requiring Service**—Unplug this video product from the wall outlet and refer servicing to qualified service personnel under the following conditions:  
When the power-supply cord or plug is damaged.

If liquid has been spilled, or objects have fallen into the video product.

If the video product has been exposed to rain or water.

If the video product has been dropped or the cabinet has been damaged.

If the video product does not operate normally be following the operating instructions. Adjust only those controls that are covered by the operating instructions as an improper adjustment of other controls may result in damage and will often require extensive work by a qualified technician to restore the video product to its normal operation.

When the video product exhibits a distinct change in performance - this indicates a need for service.

**Replacement Parts**—When replacement parts are required, be sure the service technician has used replacement parts specified by the manufacturer or have the same characteristics as the original part. Unauthorized substitutions may result in fire, electric shock or other hazards.

**Safety Check**—Upon completion of any service or repairs to this video product, ask the service technician to perform safety checks to determine that the video product is in proper operating condition.

### Before Using the Camera

Read the back side before using the camera.

#### ■ Test Shots Prior to Photography

For important photographs (such as weddings and overseas trips), always take a test shot and view the image to make sure that the camera is working normally.

• FUJIFILM Corporation cannot accept liability for any incidental losses (such as the costs of photography or the loss of income from photography) incurred as a result of faults with this product.

#### ■ Notes on Copyright

Images recorded using your digital camera system cannot be used in ways that infringe copyright laws without the consent of the owner, unless intended only for personal use. Note that some restrictions apply to the photographing of stage performances, entertainments and exhibits, even when intended purely for personal use. Users are also asked to note that the transfer of Memory Card containing images or data protected under copyright laws is only permissible within the restrictions imposed by those copyright laws.

#### ■ Handling Your Digital Camera

To ensure that images are recorded correctly, do not subject the camera to impact or shock while an image is being recorded.

#### ■ Liquid Crystal

If the LCD monitor is damaged, take particular care with the liquid crystal in the monitor. If any of the following situations arise, take the urgent action indicated.

• If liquid crystal comes in contact with your skin:

Wipe the area with a cloth and then wash thoroughly with soap and running water.

• If liquid crystal gets into your eye:

Flush the affected eye with clean water for at least 15 minutes and then seek medical assistance.

• If liquid crystal is swallowed:

Flush your mouth thoroughly with water. Drink large quantities of water and induce vomiting. Then seek medical assistance.

#### ■ Trademark Information

• and **xD-Picture Card™** are trademarks of FUJIFILM Corporation.

• IBM PC/AT is a registered trademark of International Business Machines Corp. of the U.S.A.

• Macintosh, Power Macintosh, iMac, PowerBook, iBook and Mac OS are trademarks of Apple Inc., registered in the U.S. and other countries.

• Microsoft, Windows, the Windows logo, Windows Vista and the Windows Vista logo are trademarks or registered trademarks of Microsoft Corporation in the United States and/or other countries. Windows is an abbreviated term referring to the Microsoft® Windows® Operating System.

\* The "Designed for Microsoft® Windows® XP" logo refers to the camera and the driver only.

• IrSimple™ Trademark is owned by the Infrared Data Association®.

• IrSS™ Trademark or IrSimpleShot™ Trademark is owned by the Infrared Data Association®.

• SDHC logo is a trademark.

• Other company or product names are trademarks or registered trademarks of the respective companies.

#### ■ Notes on Electrical Interference

If the camera is to be used in hospitals or aircrafts, please note that this camera may cause interference to other equipment in the hospital or aircraft. For details, please check with the applicable regulations.

#### ■ Explanation of Color Television System

NTSC: National Television System Committee, color television telecasting specifications adopted mainly in the U.S.A., Canada and Japan.

PAL: Phase Alternation by Line, a color television system adopted mainly by European countries and China.

#### ■ Exif Print (Exif ver. 2.2)

Exif Print Format is a newly revised digital camera file format that contains a variety of shooting information for optimal printing.

\* See "Using Your Camera Correctly"

(→OWNER'S MANUAL) for more information.

⇒ Also, read the back page.

## FUJIFILM

FUJIFILM Corporation

7-3, AKASAKA 9-CHOME, MINATO-KU, TOKYO 107-0052, JAPAN

[http://www.fujifilm.com/products/digital\\_cameras/index.html](http://www.fujifilm.com/products/digital_cameras/index.html)

